

CLOSE QUARTER COMBAT

(BILINGUAL)

WARNING

Although not classified this publication, or any part of it, may be exempt from disclosure to the public under the Access to Information Act. All elements of information contained herein must be closely scrutinized to ascertain whether or not the publication, or any part of it may be released.

Issued on Authority of the Chief of the Defence Staff

OPI: SSO INF/FMC HQ

**1988-09-28
Ch 2 - 1992-08-24**

LIST OF EFFECTIVE PAGES

Insert latest changed pages; dispose of supersede pages in accordance with applicable orders.

NOTE

The portion of the text affected by the latest change is indicated by a black vertical line in the margin of the page. Changes to illustrations are indicated by miniature pointing hands or black vertical lines.

Dates of issue for original and changed pages are:

Original	Ch.....6
Page.....01988-09-28	Ch.....7
Ch.....11991-01-07	Ch.....8
Ch.....21992-08-24	Ch.....9
Ch.....3	Ch.....10
Ch.....4	Ch.....11
Ch.....5	Ch.....12

Zero in Change No. Column indicates an original page. The use of the letter E or F indicates the change is in English or French only. Total number of pages in this publication is 155 consisting of the following:

Page No.	Change No.	Page No.	Change No.
Title	2	8-1 to 8-4	0
A	2	9-1 to 9-8	0
i/ii	0	10-1 to 10-10	0
iii/iv	0	11-1 to 11-5/11-6	0
v/vi	0	12-1 to 12-6	0
vii to ix	0	13-1 to 13-9/13-10	0
x	2	14-1, 14-2	0
xi to xiv	0	15-1 to 15-14	1
xv, xvi	2	15A-1 to 15A-6	1
1-1, 1-2	0	15B-1 to 15B-9/15B-10	1
2-1 to 2-5/2-6	0	15C-1 to 15C-3/15C-4	2
3-1 to 3-7/3-8	0	16-1	0
4-1 to 4-12	0	16-2, 16-3/16-4	1
5-1 to 5-11/5-12	0	A-1 to A-4	0
6-1 to 6-16	0	B-1, B-2	0
7-1 to 7-6	0		

Contact Officer: SSO INF/FMC HQ

© 1988 DND/MDN Canada

WARNING

USE OF THIS MANUAL

1. The techniques in this manual are the basic techniques from which most hand to hand fighting was developed. **Instructors shall teach the techniques in this manual rather than their individual styles.**
2. All close quarter combat training shall be supervised closely by a qualified instructor. An adequate ratio is one instructor/assistant instructor for every 10 student pairs (20 students).
3. Intentional striking of an individual by another, and horseplay, is prohibited.
4. Student partners shall be made aware of the specific technique to be practised before it is executed.
5. When practising knife and bayonet techniques ensure that scabbards are firmly attached and taped on. For rifle and pistol techniques, ensure fingers are not placed in trigger guards. Approved safety equipment, when available, shall be used.
6. A first aid kit and stretcher shall be available and at least one person qualified Standard First Aid shall be present during all training sessions and demonstration.

FOREWORD

GENERAL

1. B-GL-318-018/PT-001, CF Close Quarter Combat Manual, is issued on the authority of the Deputy Minister and Chief of the Defence Staff.
2. This publication, dated 28 September 1988, is effective on receipt.
3. Any loss or suspected compromise of this publication, or portions thereof, must be reported in accordance with A-SJ-100-001/AS-000, Chapter 34.

SCOPE

4. This manual covers basic close quarter fighting techniques including unarmed hand-to-hand fighting, bayonet fighting, and knife fighting.
5. This publication is the basic reference for close quarter battle training in the Army. As such it is intended for the use of qualified unarmed combat instructors.

CHANGES

6. Comments and suggestions for changes should be forwarded through the usual channels to FMC HQ Attention: SSO Infantry.

CONTENTS

CHAPTER 1 - BASIC PRINCIPLES UNDERLYING UNARMED COMBAT TECHNIQUES

Introduction
Form, Balance, and Center of Gravity
Power and Speed
Concentration of Force
Muscular Power
Lower Abdomen and Hips

CHAPTER 2 - STRIKING SURFACES

General
Use of the Hands
Use of the Feet
Use of the Elbow
Use of the Knee

CHAPTER 3 - STANCES AND POSTURE

Correct Form
Good Stance
Attention Stance
Natural Stance
Straddle Stance
Striking Stance/Front Stance
Fighting Stance

CHAPTER 4 - PUNCHING

Fundamentals of a Straight Punch
Concentration of Power
Training Method for Basic Straight Punch
The Reverse Punch
Training Method for Reverse Punch
Effect of Stance on Attacking Range in Reverse Punch
Lunge Punch - General
Important Considerations in Lunge Punch
Training Method for Lunge Punch

CHAPTER 5 - KICKS

Kicking Theory and Practice
Factors in Kicking

Important Points in Raising and Bending the Knee

Snap Kick

Thrust Kick

Rear Leg Kick Training Method

Front Kick Body Position

Back Kick

Stamping Kick

Foot Sweep

CHAPTER 6 - BLOCKS

General

Factor 1 - Direction of Power in the Block

Factor 2 - Forearm Rotation and Timing

Factor 3 - Hip Rotation

Upper Block Against Head Attack

Training Method for Upper Block

Outside Middle Block

Training Method Outside Middle Block

Factor 4 - Position of Elbow of

Blocking Arm

Inside Middle Block

Training Method for Middle

Inside Block

Downward Block

Training Method for Downward Block

Conclusion on Blocking

CHAPTER 7 - ELBOW AND KNEE STRIKES

Elbow Strikes - General

Important Considerations

Elbow Strike Training Method

Training Method for Upward Elbow Strike

Striking Techniques with the Knee

CHAPTER 8 - BASIC MOVEMENT

Stance Training in Continuous

Movement

Moving from the Left-Front Stance to the Right-Front Stance

Things to Avoid

Training Method - Thrusting Hips

Forward

Things to Avoid

CHAPTER 9 - HOLDS AND COUNTERS

General
Rear Strangle Hold
Rear Strangle Hold (American)
Claw
Bent Wrist Lock
Arm Bow
Summary on Holds
Hold Counter-Moves - General
Counters to a Choke Hold
Counter to Rear Strangle Hold
Counter to a Head Lock
Counter to a Bear Hug
Conclusion on Counters

CHAPTER 10 - KNIFE FIGHTING/DEFENSE

General
Grip
Stance
Stab Moving Forward
Stab Lunging Forward
Slash
Front Attack
Attack from the Rear
Defence Against Knife Attack

CHAPTER 11 - DEFENCE AND COUNTERS

Steps in Combining Blocking Techniques with Decisive Counter Attacks

Important Considerations
Defence and Counters from Upper Attacks
Double Inside Block to Front Kick

CHAPTER 12 - BASIC TRAINING DRILLS

General
Lunge Punch
Upper Block
Forearm Block to Elbow Strike

CHAPTER 13 - SPECIAL TECHNIQUES

Strangulation

Helmet Neck Break
Helmet Smash
Crotch Take Down

Available Weapons
Rear Take-Down
Rifle at Your Back
Rifle in Front
Pistol in Back
Pistol in Front
Points about Rifles and Pistols

CHAPTER 14 - HAND-HELD WEAPONS

General

CHAPTER 15 - BAYONET/PUGIL STICK FIGHTING

General
Principles
Basic Bayonet Movements
Movements Following a Failed Attack

Combination Movements
Pugil Stick Drill
Conduct of Training
Combat

Annex A - Lesson Guide

Annex B - Pugil Stick Drill Equipment

Annex C - Bayonet Fighting Training Apparatus

CHAPTER 16 - VULNERABLE POINTS OF THE BODY

General
Vulnerable Points in the Head and Neck Region
Vulnerable Point of the Trunk
Vulnerable Points of the Limbs

ANNEX

A - NOTES TO INSTRUCTORS

B - CALISTHENICS EXERCISES

LIST OF FIGURES

FIGURE	TITLE
2-1	Making a Fist
2-2	Forefist
2-3	Forefist (Side View)
2-4	Forefist Strike
2-5	Backfist
2-6	Backfist Strike
2-7	Hammer Fist
2-8	Hammer Fist Strike
2-9	Ball of the Foot
2-10	Ball of Foot Strike
2-11	Instep
2-12	Instep Strike
2-13	Heel
2-14	Heel Strike
2-15	Elbow
2-16	Elbow Strike
2-17	Knee
2-18	Knee Strike
3-1	Attention Stance
3-2	Natural Stance
3-3	Straddle Stance (Front View)
3-4	Straddle Stance (Side View)
3-5	Striking Stance/Front Stance
3-6	Striking Stance/Front Stance (Side View)
3-7	Fighting Stance (Side View)
3-8	Fighting Stance
3-9	Leg Position Fighting Stance (Front View)
3-10	Leg Position Fighting Stance (Side View)
3-11	Front Knee Bent Too Far and Heel of Rear Foot Raised
3-12	Front Knee Faces Outside and Front Foot Not Firm
4-1	The Fists
4-2	Body Movement
4-3	Concentration of Power
4-4	Sequence of Delivering a Thrust Punch
4-5	Straight Punch
4-6	Straight Punch - Shoulder Raised Too High
4-7	Straight Punch - Follow-Through
4-8	Start Position for Reverse Punch
4-9	Reverse Punch
4-10	Knee of Rear Leg is Depressed and Heel Raised

- 4-11 Right Hip is Left Behind and Upper Body Leans Forward
- 4-12 Upper Body Leans to Right
- 4-13 Stance
- 4-14 Lunge Punch (Side View)
- 4-15 Lunge Punch (Front View)
- 4-16 Lunge Punch - Training Method

- 5-1 The Kick
- 5-2 Leg Position in Preparation for the Kick (Front View)
- 5-3 Leg Position in Preparation for the Kick (Side View)
- 5-4 Snap Kick
- 5-5 Thrust Kick
- 5-6 Thrust Kick to Head
- 5-7 Rear Leg Kick
- 5-8 Rear Leg Kick - Leaning Too Far Forward
- 5-9 Front Kick Body Position
- 5-10 Front Kick Body Position - Leaning Forward
- 5-11 Back Kick Sequence
- 5-12 Stamping Kick
- 5-13 Foot Sweep (Front View)
- 5-14 Foot Sweep (Rear View)
- 5-15 Foot Sweep Sequence

- 6-1 Blocking
- 6-2 Block Against a Head Attack
- 6-3 Upper Block Against Head Attack
- 6-4 Preparing to Block
- 6-5 Blocking from Inside Outward
- 6-6 Block Outside Inward
- 6-7 Blocking a Thrust to the Head
- 6-8 Blocking: - Arm to High
- 6-9 Blocking: - Arm Too Far From Head
- 6-10 Outside Middle Block Sequence
- 6-11 Training Method Outside Middle Block
- 6-12 Elbow Position
- 6-13 Inside Middle Block
- 6-14 Inside Middle Block Sequence (Side View)
- 6-15 Inside Middle Block Sequence (Front View)
- 6-16 Inside Middle Block - Arm Cross
- 6-17 Inside Outward Block Sequence

- 6-18 Downward Block Sequence
- 6-19 Downward Block Application

- 7-1 Elbow Strike
- 7-2 Elbow Strike Training Method (Front View)

- 7-3 Elbow Strike Training Method (Side View)
- 7-4 Upward Elbow Strike Sequence
- 7-5 Upward Elbow Strike
- 7-6 Knee to Head, Start Position
- 7-7 Knee to Head
- 7-8 Knee to Groin, Start Position
- 7-9 Knee to Groin

- 8-1 Front Stance - Advancing and Retreating
- 8-2 Front Stance - Advancing and Retreating (Foot Movement)
- 8-3 Thrusting Hips Forward
- 8-4 Training Method for Thrusting Hips Forward

- 9-1 Strangle Hold
- 9-2 Rear Strangle Hold (American)
- 9-3 Claw
- 9-4 Bent Wrist Lock
- 9-5 Arm Bow Sequence
- 9-6 Choke Hold Counters
- 9-7 Strangle Hold Counter
- 9-8 Twist
- 9-9 Bite
- 9-10 Grab
- 9-11 Gouge
- 9-12 Bear Hug Counter - Stomp
- 9-13 Bear Hug Counter - Smash
- 9-14 Bear Hug Counter - Grab

- 10-1 Knives
- 10-2 Knife Grip
- 10-3 Stance
- 10-4 Stab Moving Forward
- 10-5 Stab
- 10-6 Slash
- 10-7 The Throat
- 10-8 Stomach
- 10-9 Heart
- 10-10 Wrist
- 10-11 Upper Arm
- 10-12 The Leg
- 10-13 The Kidney
- 10-14 Side of the Neck
- 10-15 Throat
- 10-16 Subclavian Artery
- 10-17 Defend Yourself with any Available Object such as a Stick
- 10-18 Use of Jacket to Aid Countering Knife-Attack

- 10-19 Use of Webbing to Counter Knife-Attack
- 10-20 Disarming Attacker with Knife
- 10-21 Counter to Knife Attack
- 10-22 Downward Counter to Knife Thrust
- 10-23 Relieving Opponent of Knife

- 11-1 Counter to Upper Attack
- 11-2 Deception Move
- 11-3 Elbow Smash Counter Sequence
- 11-4 Upper Block Front Snap Kick (Relatively Close Range)
- 11-5 Block from Outside Inward with Bottom of Wrist to Reverse Punch (Ordinary Distance)
- 11-6 Block from Outside Inward with Bottom of Wrist to Elbow Strike (Closer than Normal Distance)
- 11-7 Block from Outside Inward with Bottom of Wrist to Elbow Strike (Closer than Normal Distance)

- 12-1 Basic Training Movements
- 12-2 Lunge Punch Training Movements
- 12-3 Upper Block Training Movements

- 13-1 Garrot
- 13-2 Strangulation Using a Garrot
- 13-3 Rearward Approach with Garrot
- 13-4 Two Hand Loop Strangulation
- 13-5 Helmet Neck Break
- 13-6 Helmet Smash
- 13-7 Crotch Take Down
- 13-8 Homemade Blackjack
- 13-9 Rear Take-Down
- 13-10 Rifle at Back
- 13-11 Rifle in Front
- 13-12 Pistol in Back
- 13-13 Pistol in Front

- 14-1 Various Hand-Held Weapons

- 15-1 On Guard
- 15-2 Rest
- 15-3 Point, Enemy Standing
- 15-4 Point, Enemy on the Ground
- 15-5 Extraction of the Weapon
- 15-6 Left Parry
- 15-7 Right Parry
- 15-8 Horizontal Butt Stroke
- 15-9 Vertical Butt Stroke
- 15-10 Smash

- 15-11 Slash
- 15-12 High Port
- 15-13 Point, Horizontal Butt Stroke, Smash, Slash, Point (3 Pages)
- 15-14 Left Parry, Horizontal Butt Stroke, Slash, Point (2 Pages)
- 15-15 Point, Vertical Butt Stroke, Smash, Point (2 Pages)

- 15B-1 Pugil Stick Drill Equipment
- 15B-2 Characteristics of Protective Mask
- 15B-3 Protective Helmet and Mask
- 15B-4 Materials Required to Make a Pugil Stick
- 15B-5 Steps in Making a Pugil Stick

- 15C-1 The Mannequin
- 15C-2 The Ground Sack
- 15C-3 The Scaffold

- 16-1 Vulnerable Points of the Body
- 16-2 Vulnerable Points

CHAPTER 1

BASIC PRINCIPLES UNDERLYING UNARMED COMBAT TECHNIQUES

INTRODUCTION

1. Punching, Striking, Kicking and Blocking are the fundamentals of unarmed combat. They are at once the beginning and the final goal. The soldier can easily learn to perform these basic movements in two or three months, but perfection in their performance may be impossible. Therefore, a soldier must practice regularly and employ maximum concentration and effort in the performance of each movement.

FORM, BALANCE, AND CENTER OF GRAVITY

2. It has been recognized for many years that there is a requirement for correct form for the effectiveness of techniques. It is essential in unarmed combat that all parts of the body harmonize to provide the stability and power necessary to sustain the shock of delivering an effective kick or punch. This can only be achieved through proper form.

3. Balance is of prime importance because often in the offence the soldier is on one foot to kick or strike. He must generate power if his kick is to be effective, and that cannot be achieved without balance.

4. If the feet are placed far apart, then the centre of gravity is lowered, resulting in stronger techniques. However, it is easier to move if the centre of gravity is somewhat higher. If you don't move, your opponent will attack. Therefore, the soldier must constantly shift his centre of gravity to effectively move and strike.

POWER AND SPEED

5. Effective use of strength is important, but muscle strength alone will accomplish very little. **POWER IS ACHIEVED BY THE CONCENTRATION OF MAXIMUM FORCE AT THE MOMENT OF IMPACT.** The concentration of force depends greatly upon the speed with which movements are executed. However, speed cannot achieve its greatest effect without good control. Greater speed can be generated if power travels a longer route to its target.

CONCENTRATION OF FORCE

6. A punch or kick will be weak if applied with the arm or leg alone. **TO ACHIEVE MAXIMUM POWER, IT IS NECESSARY TO USE THE STRENGTH OF ALL PARTS OF THE BODY SIMULTANEOUSLY.** Power concentrated at the time of focus must be instantly released to prepare for the succeeding action. It is important that various muscles and tendons be kept loose and relaxed to permit instant response to changing circumstances.

MUSCULAR POWER

7. Well trained, powerful and elastic muscles are mandatory in unarmed combat.
8. Rhythm is the smooth transition of the body from one movement to the next. Timing is the application of the technique. If timing is faulty, the technique will fail. A kick or punch which is directed at a target either too early or too late is often fruitless. The attack must be launched with the hands and feet in the usual position of readiness or defence. The hands and feet must be in a position where they lend to the defence and can be applied to the attack. The body must remain relaxed but alert, with the muscles full of energy and ready for any eventuality.

LOWER ABDOMEN AND HIPS

9. The centre of the body, ie, the lower abdominal area and the hips, play a great part in all techniques. IT PROVIDES BASIC POWER AND BALANCE. Therefore, punch with the hips, kick with the hips and block with the hips.

CHAPTER 2

STRIKING SURFACES

GENERAL

1. In unarmed combat many parts of the body can serve as weapons. The hands, elbows, feet and knees are most utilized and they become effective and powerful weapons when strengthened through proper training.
2. Merely hardening the fist is useless. The fist can only serve as a strong weapon when supported by the power of the wrist, elbow, arm and other parts of the body.

USE OF THE HANDS

3. **The Hand.** The hand can be used both opened and closed. For the beginner a fist is most effective. To form a fist, fold the fingers inward at the middle joints. The tips should reach the base of the fingers. Continue bending the fingers inward until they are tightly pressed into the palm. Fold the thumb over the fingers and firmly press the index and middle fingers with the thumb. In forming a fist in this way, the little finger tends to become weak and relaxed. Take care to prevent this from occurring.

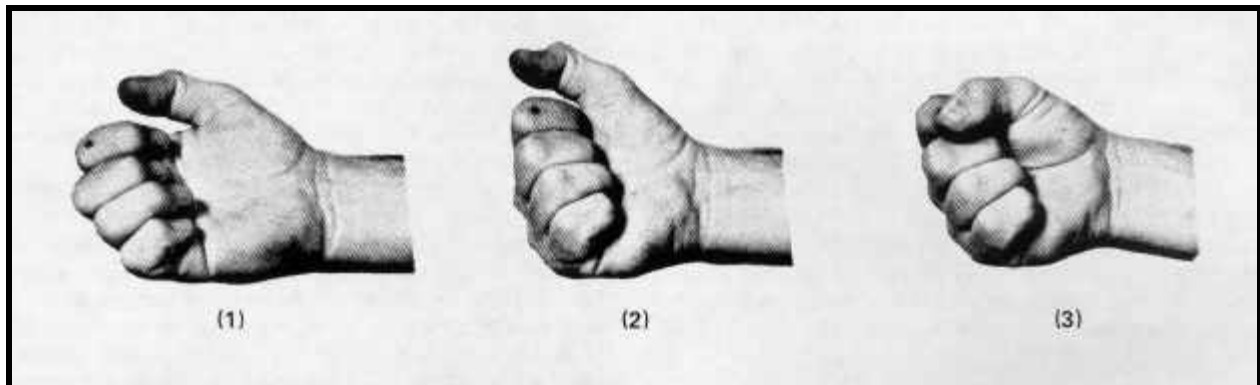

Figure 2-1 Making a Fist



Figure 2-2 Forefist

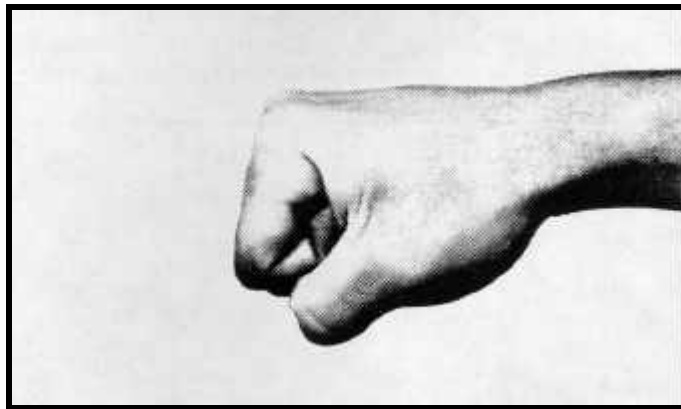

Figure 2-3 Forefist (Side View)



Figure 2-4 Forefist Strike

4. **Forefist.** This is usually employed to deliver a thrust punch. The part of the fist which hits the target is that area from slightly above the middle joint to the knuckle of the index and middle fingers. At the moment of impact all the power in the body must flow through the arm in a straight line and terminate in the fist. Tense the wrist and ensure that the wrist and the top of the fist form a straight line. If the wrist is bent, power will not be transmitted to the fist, and the wrist may be injured. Because the Forefist is employed more often than any other kind of fist in karate, training in its use must be thorough and complete.

5. **Backfist.** In the Backfist the fist is formed as in the Forefist. The part of the fist used to strike, however, is the back of the hand and the tops of the knuckles of the index and middle fingers. Backfist is used chiefly to attack the opponent's face and the side of his body. Deliver this strike with a snapping motion of the forearm.

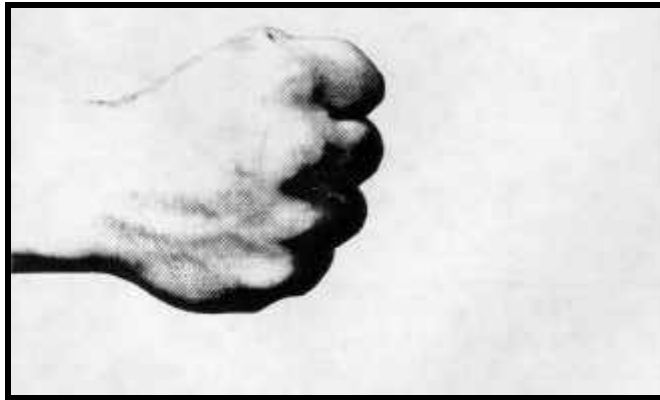

Figure 2-5 Backfist



Figure 2-6 Backfist Strike

6. **Hammer Fist.** After forming the fist, use the bottom of the fist to strike the target. As with the Backfist, make use of the snap of the forearm to deliver the attack.

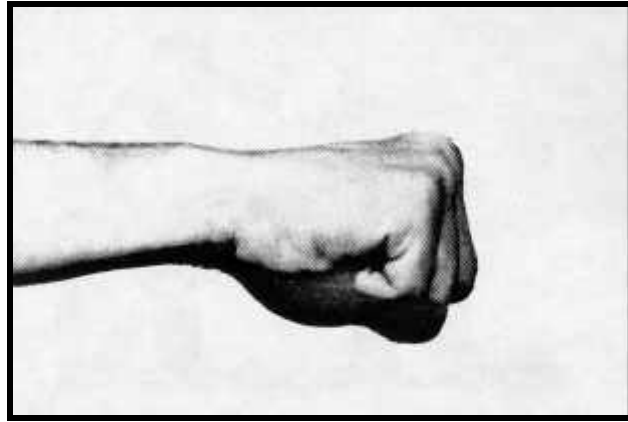

Figure 2-7 Hammer Fist

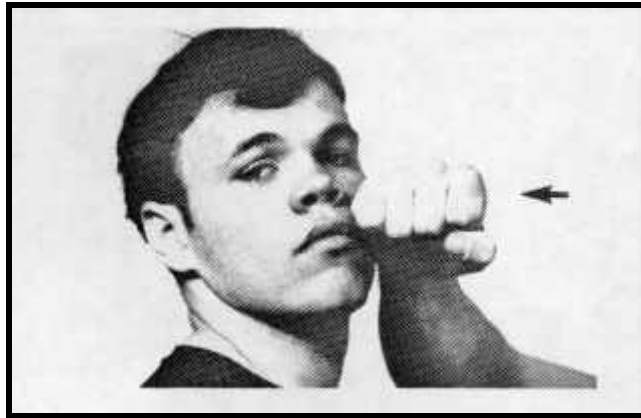

Figure 2-8 Hammer Fist Strike

USE OF THE FEET

7. The foot can deliver a blow equal in power to that of the hand.

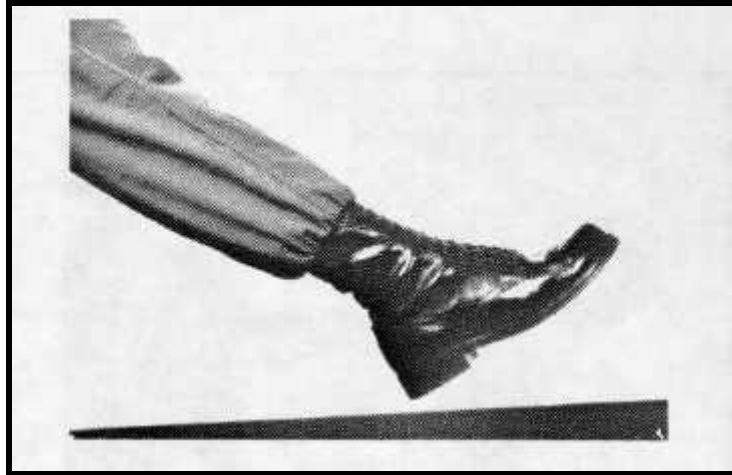

Figure 2-9 Ball of the Foot

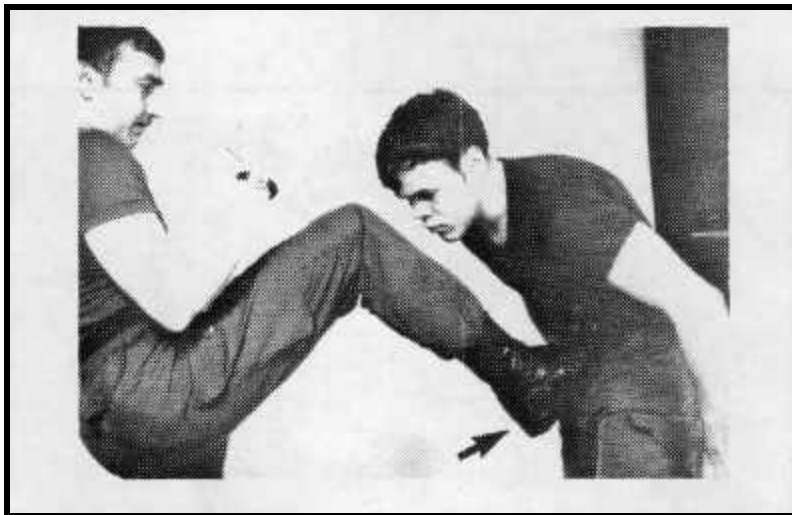

Figure 2-10 Ball of Foot Strike

8. **Ball of the Foot.** The ball of the foot can also be considered the toe of a combat boot. In unarmed combat kicks are usually delivered with the toe of a boot as the striking surface. By curling the toes upward and using the ball of the foot, it is possible to deliver kicks to the opponent's face, chest, abdomen, and groin. To kick effectively, raise the toes as much as possible, and tense the area around the toes and the ankle.

9. **Instep.** The area used in the instep is the top of the foot from the toes to the ankle. The foot is stretched downward and the toes point downward. Use Instep in kicks aimed at the groin.

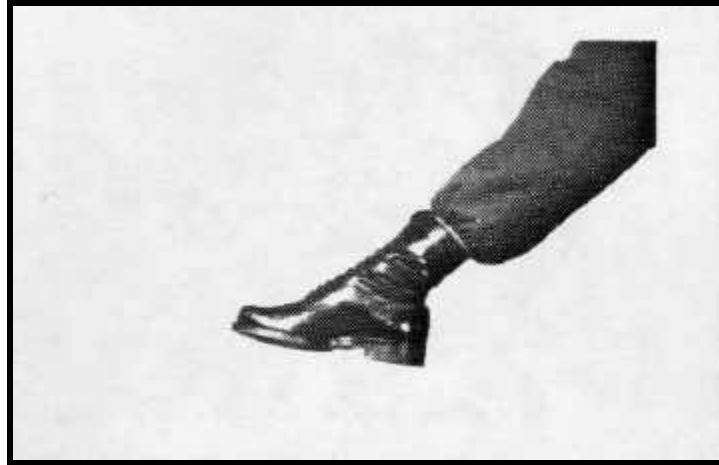

Figure 2-11 Instep

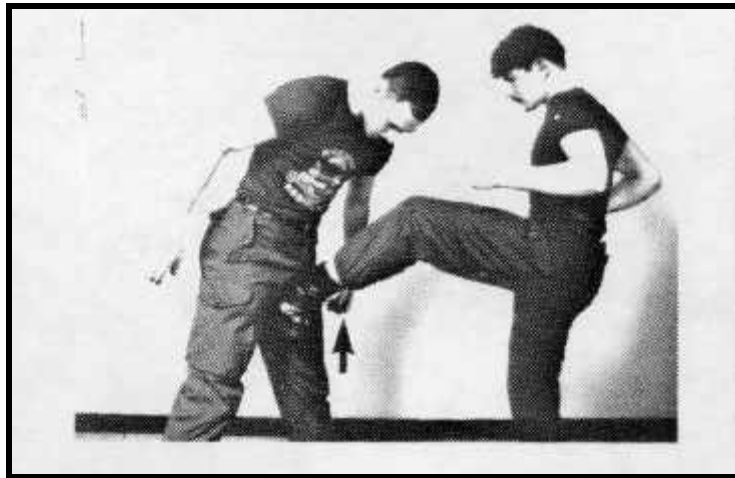

Figure 2-12 Instep Strike

10. **Heel.** This area is also called round heel. This part of the foot is used in kicks directed backwards. A back kick is highly effective against an opponent attempting to grasp your body from the rear, or one who has secured an arm hold from the side or rear.



Figure 2-13 Heel

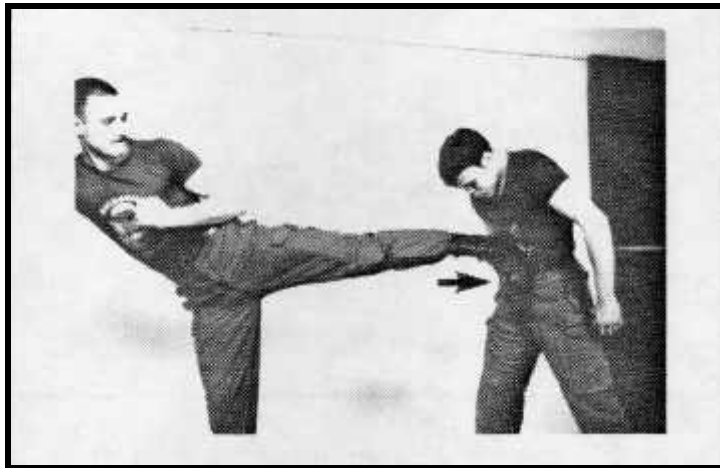

Figure 2-14 Heel Strike

USE OF THE ELBOW

11. This part of the arm can be used to deliver a powerful blow to any part of the opponent's body. For example, the face, chest, or abdomen can be attack-ed with the elbow. This strike is especially effective when the opponent is standing very close. Elbow strikes are possible against an opponent standing at the front, the rear, or the side. The strike may travel upward, downward, and in a half circle, as well as in a straight line parallel to the ground. In performing these strikes, the section all around the tip of the elbow can be used, but the area actually selected will depend on the direction of the strike.

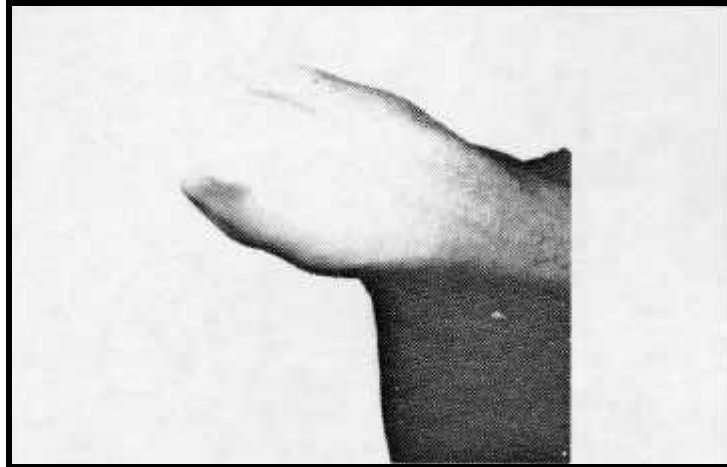

Figure 2-15 Elbow

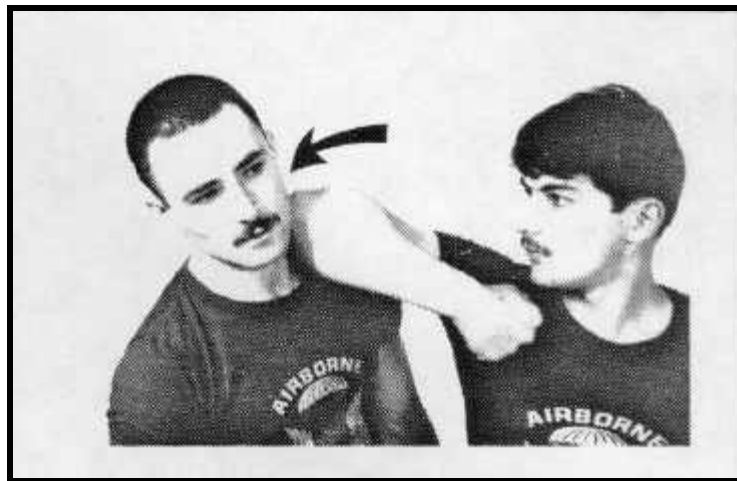

Figure 2-16 Elbow Strike

USE OF THE KNEE

12. As in the case of the elbow, use the knee in close-in fighting to attack the groin, the side of the body, and the thighs. Other areas useful for striking, such as the head, the forehead, and the shoulder have not been mentioned here. Remember that many areas of the body can serve to deliver offensive and defensive techniques. Study the construction of the body to discover additional possibilities.



Figure 2-17 Knee

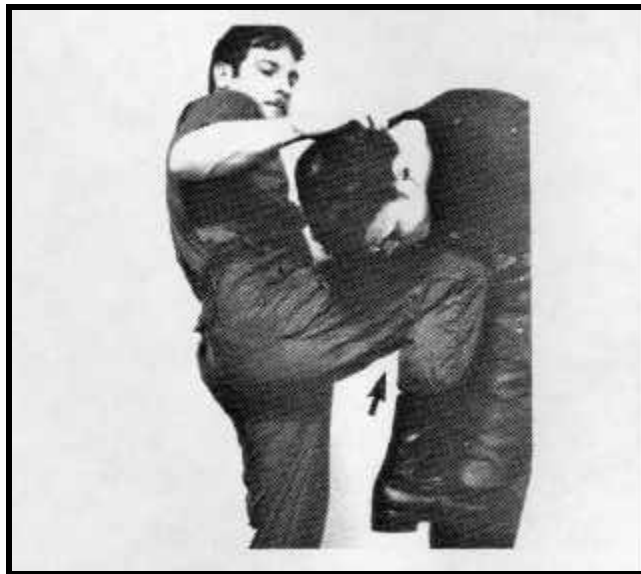

Figure 2-18 Knee Strike

CHAPTER 3

STANCES AND POSTURE

CORRECT FORM

1. If the body lacks balance and stability, offensive and defensive techniques will be ineffective. The ability to defend against an attack under any circumstances depends largely upon the maintenance of correct form.

2. Stance in unarmed combat is mainly concerned with the position of the lower part of the body. Powerful, fast, accurate, and smoothly executed techniques can be performed only from a strong and stable base. The upper body must be firmly settled on this strong base, and the back kept straight, on perpendicular to the ground. Although an effective attack is impossible without a strong stance, it is only necessary to assume this position just before delivering an attack. If the soldier concentrates too much on remaining in a firm and stable position, he will lose mobility.

GOOD STANCE

3. In addition to the above, the following points are closely related to the development of a good stance. The soldier must:
 - a. be well balanced when applying offensive or defensive techniques;
 - b. rotate his hips smoothly when executing techniques;
 - c. apply his techniques with the greatest possible speed; and
 - d. ensure that the muscles used in attack or defence work together harmoniously.

4. Therefore, the first consideration is the establishment of a strong and stable base. From this base all parts of the body must work together harmoniously as a single unit. In other words, the feet, legs, trunk, arms, and hands must be well controlled individually, but at the same time work together as a unit.

5. It is detrimental to the development of beginners if, instead of concentrating on basic training, they attempt to imitate the stance used by advanced students. The advanced may stand very lightly with their hips in a relatively high position. However, they can change this stance in an instant to a very strong and firm one with the hips low. It is difficult for beginners to duplicate this change, for the obvious reason that advanced students have spent a much longer time practicing. If beginners stand like the advanced, they will lose their balance at the moment of focusing on the technique.

6. It is important to remember that in addition to stability while in a ready or defensive position, the stance must provide enough strength and firmness to withstand the shock caused by the application of techniques.



Figure 3-1 Attention Stance



Figure 3-2 Natural Stance

ATTENTION STANCE

7. Keep the feet at 45 degree angles to one another. Knees are straight, but relaxed.

NATURAL STANCE

8. This stance is perhaps the most natural and comfortable of all the stances. Place the feet so that the heels are separated by a distance roughly equal to the width of the hips, and point the toes outward at 45 degree angles. One foot should not be ahead of the other. A straight line should bisect both heels.

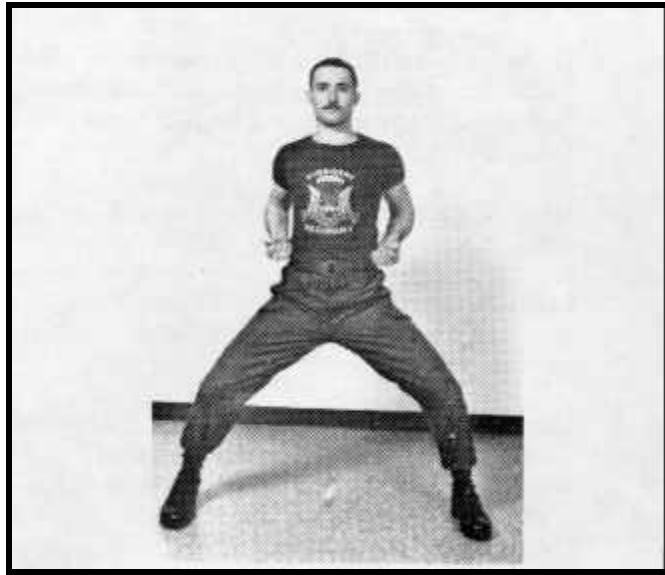

Figure 3-3 Straddle Stance (Front View)

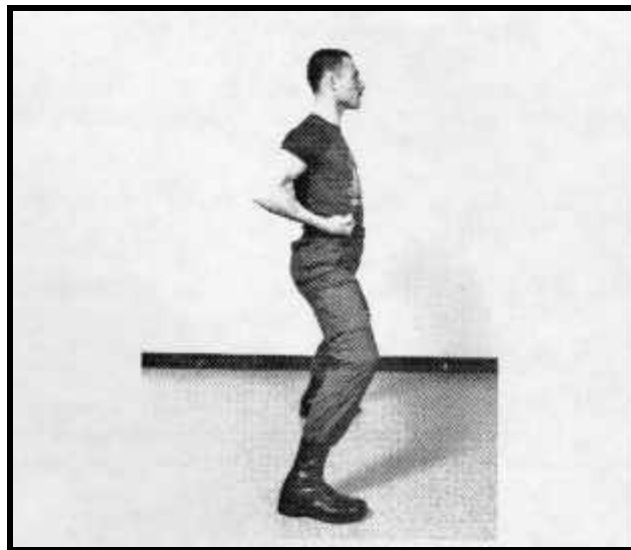

Figure 3-4 Straddle Stance (Side View)

STRADDLE STANCE

9. **General Considerations.** To perform the straddle stance properly, bend the knees, keep the upper body perpendicular to the ground, and face straight ahead. This position roughly resembles that taken by a man astride a horse. The straddle-leg stance is strong to the side and used when applying techniques to the side. For example, elbow strike and back-fist strike are delivered from this position.

10. **Specific Points -**

- a. Maintain the upper body in a position perpendicular to the ground, and do not lean either to the front or to the rear, otherwise stability will be impaired.
- b. Force the feet inward to overcome the tendency for them to turn outward.
- c. Be sure that the position of the knees corresponds to that marked in the diagram, and that the soles of the feet are placed firmly on the ground.
- d. Flex the ankles and knees so that the knees remain in the correct position.
- e. Keep the hips low. If the knees are straightened, the hips will rise.
- f. Keep the buttocks flexed, but prevent their extension to the rear. If this occurs, the upper part of the body will lean forward.

11. **Common Faults -**

- a. The distance between the feet is appreciably greater or smaller than 32 inches. However, remember that this width varies according to body structure.
- b. Not all of the sole of the foot is in firm contact with the ground.
- c. **The feet point outward.** Keep the feet pointing forward and slightly inwards.
- d. **The knees point inward.** Direct the knees forward and outward so that a plumb line dropped from the centre of the knee falls just inside of the big toe.
- e. The centre of gravity shifts from the point marked in the diagram.
- f. One leg bears more weight than the other. Support the body weight equally on both legs.

- g. **The knees are permitted to relax.** Flex the knees and direct power outward to the side. Simultaneously, flex the buttocks.



Figure 3-5 Striking Stance/Front Stance

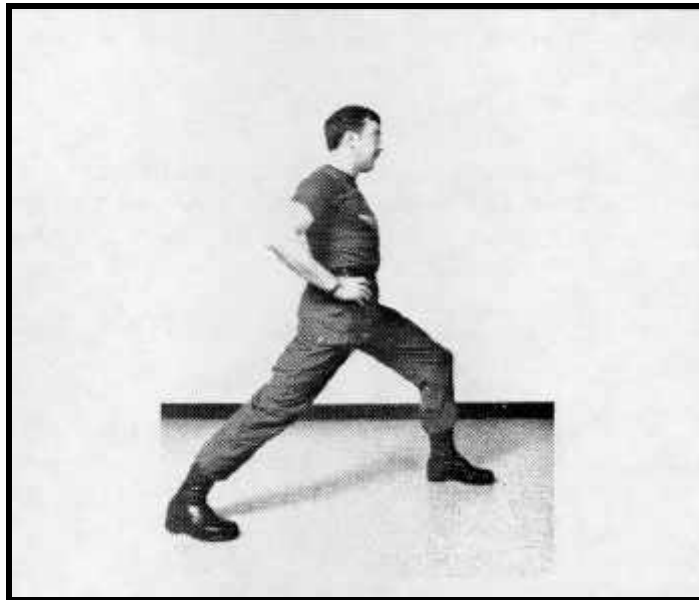

Figure 3-6 Striking Stance/Front Stance (Side View)

STRIKING STANCE/FRONT STANCE

12. **General Considerations.** Be sure there is enough space between the front and rear foot. Lower the hips. Bend the front knee so it is over the front foot as in the diagram. Keep the back leg straight. Maintain a straight back with the upper body perpendicular to the ground. It is possible to face either directly forward or at fighting stance (half-front-facing position). In the latter position, maintain the hips and shoulders at a 45 degree angle to the front, but face directly forward.

13. The front stance is a strong stance to the front and is especially effective when power must be directed forward. It is used to block an attack coming from the front, but is it also a strong position from which to attack a target directly ahead.

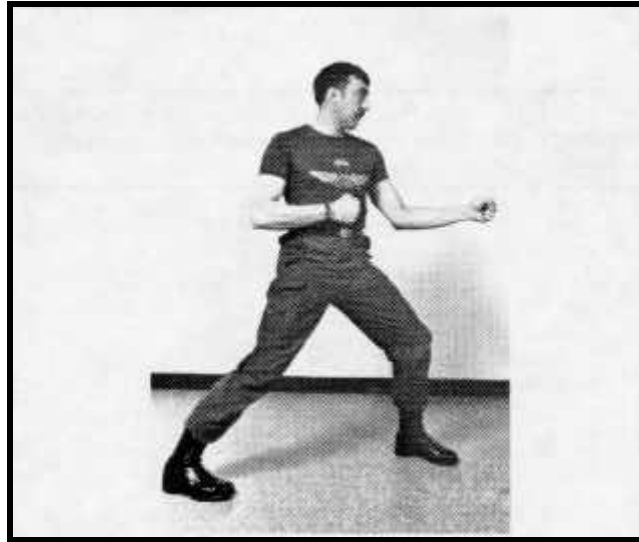

Figure 3-7 Fighting Stance (Side View)

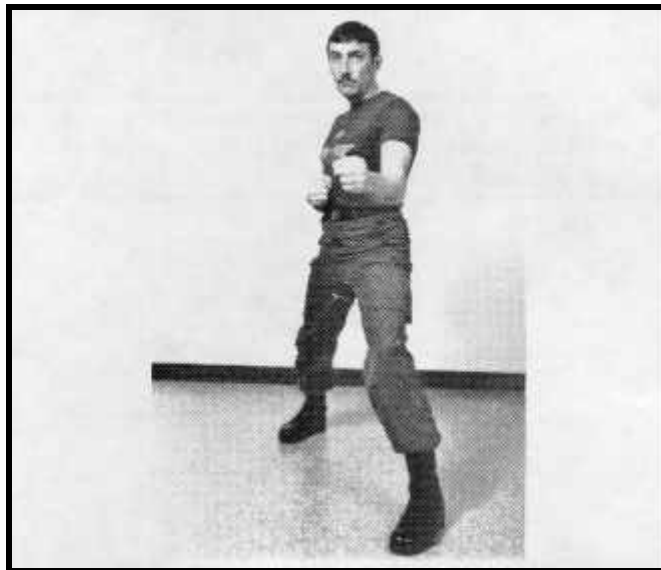

Figure 3-8 Fighting Stance

FIGHTING STANCE

14. The fighting stance is a variation to the front stance. Feet remain in the same position, the hips however rotate 30 degrees to the rear. In doing so vulnerable points such as groin and solar plex are protected from a frontal attack. The fighting stance is effective for blocking a strong attack and delivering an immediate counter attack. In this stance exert force outward on the forward knee, bend the rear knee and distribute 60% of the body weight forward.

15. Specific Points to Remember -

- a. Keep a distance of about 32 inches between the front and back feet. Maintain a width between the feet equivalent to the width of the hips.
- b. Tighten the ankles and knees of both legs and keep the soles of the feet firmly in contact with the ground.

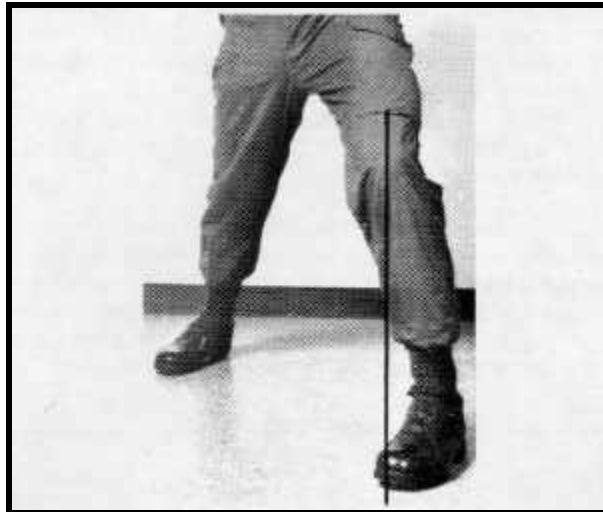

Figure 3-9 Leg Position Fighting Stance (Front View)

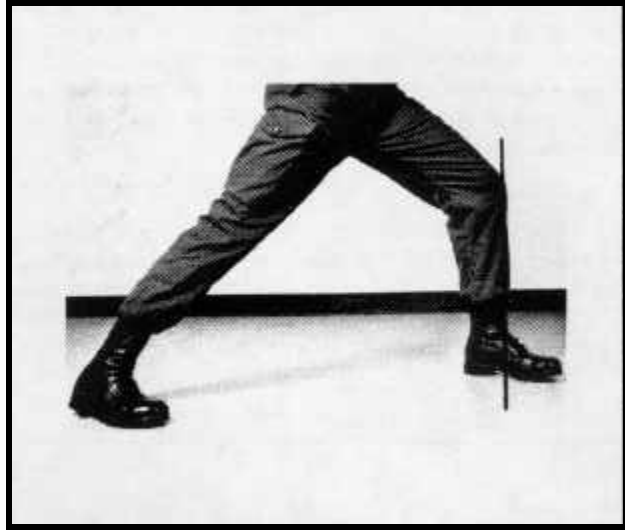

Figure 3-10 Leg Position Fighting Stance (Side View)

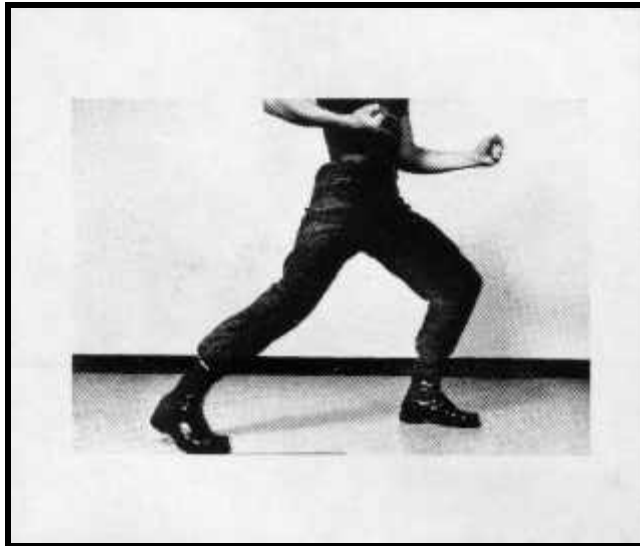

Figure 3-11 Front Knee Bent Too Far and Heel of Rear Foot Raised



Figure 3-12 Front Knee Faces Outside and Front Foot Not Firm

- c. Point the front foot slightly inward. Turn the back foot to the front as much as possible so that both feet point in about the same direction.
 - d. Place the knee of the front leg in such a position that a plumb line dropped from its centre will fall just to the inside of the ball of the foot.
 - e. Distribute the body weight so that the front leg supports about 60 and the rear leg 40 percent. The centre of gravity is thus closer to the front foot.
16. **Common Faults -**
- a. Too much weight is placed on the front foot, and the heel of the rear foot is not firmly on the ground. This undermines stability.
 - b. One foot is placed directly behind the other, reducing the distance between the feet to less than the width of the hips. This lessens stability and balance to the side. Moreover, balance to the front and to the rear will be weakened if the feet are placed wider apart than the distance between the hips.
 - c. The front foot points outward instead of slightly inward or the rear foot points to the side instead of forward. These faults impair stability.
 - d. The front knee is straightened instead of being bent. This raises the level of the hips and reduces stability.

- e. The knee of the leading leg moves too much to one side or the other of the point marked in the diagram. This weakens the knee in the direction of the error.
- f. The front ankle is not fully flexed. This causes a corresponding looseness in the knee and results in an unstable position.

CHAPTER 4

PUNCHING

FUNDAMENTALS OF A STRAIGHT PUNCH

1. The Straight Punch is really a thrust punch delivered at a target directly ahead. Turn the forearm inward 180 degrees and extend the arm as if it were a knife thrust forward from the side. This action will impart a powerful shock to the target.
2. With continuous daily practice, this punch can be a lethal weapon, but this practice must be properly done if it is to be effective. Therefore, the soldier must concentrate on the following points of training.
3. **Speed.** The formidable shocking power of karate techniques results from the momentum generated by the movement of various parts of the body, climaxed by a focus of these components at the instant of contact with the target. Speed is a major requirement in this operation. In fact, speed is of first importance from start to finish in the training in fundamental techniques.

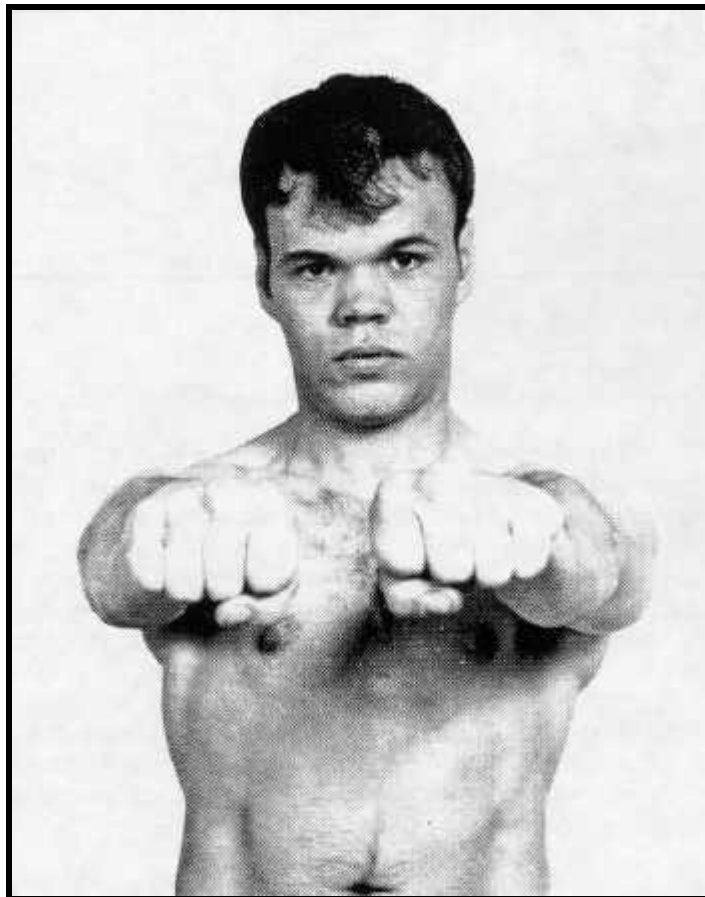

Figure 4-1 The Fists

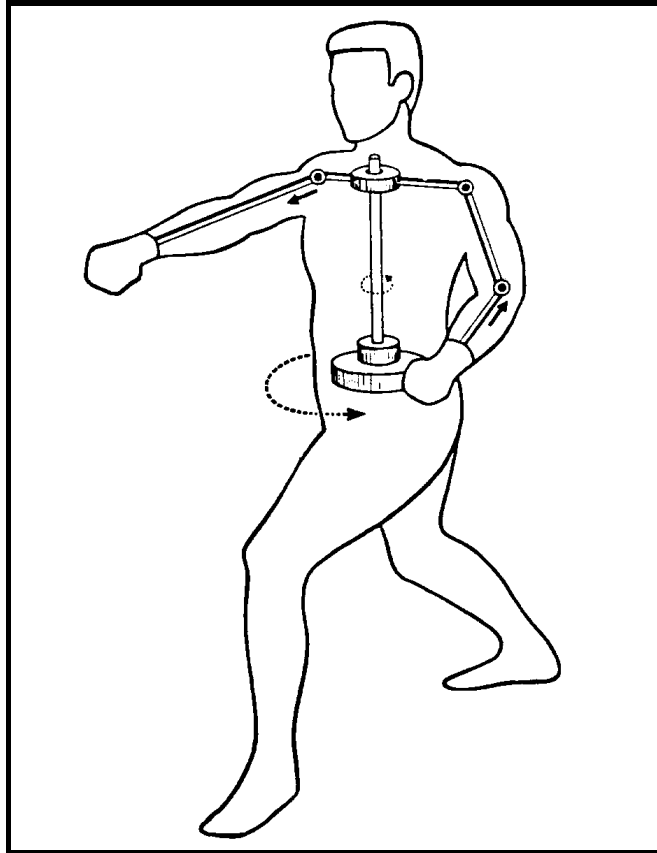

Figure 4-2 Body Movement

4. As illustrated in Figure 4-2 the movement of the body is, in general, operated by three components. The faster the muscles are tensed, the more speed and, ultimately, the more power will be in the punch or kick.
5. To increase the speed of a punch, make use of the reaction of the opposite arm. The faster you retract the opposite arm, the more speed and power will be evident in your punch.
6. When the arm is stretched during the course of a punch, one group of arm muscles stretches while another contracts. Proper balance must prevail between these two muscle groups for a speedy and effective punch. If, for example, the muscles which must stretch are tensed, the arm movement will lack smoothness and the punch will be ineffective.



Figure 4-3 Concentration of Power

CONCENTRATION OF POWER

7. Deliver a thrust punch by stretching the arm smoothly and rapidly toward the target. Release all unnecessary tension from the arm and hand at the start, but be sure to concentrate all the power of the body in the punching fist at the moment of impact. Make use of the reservoir of power stored in the hips as you begin your punch. This power flows through, and is increased by, the muscles of the chest, shoulder, upper arm and forearm. This principle also holds true in the case of a strike or a kick. Remember that an effective technique in karate is produced by a concentrated blast of power at the moment of impact.

8. The figures illustrate the method of power concentration. Notice that the muscles at the front and side of the abdomen are strongly tensed, linking the chest and hipbones firmly together. When the hips are properly set and the body is correctly supported by the thigh muscles, the standing position is firm and stable. This stable foundation enables the power of the hips to flow to the chest, shoulder and arm. In the photos the arm muscles used in raising the arm and those which straighten the arm are strongly tensed, as are the forearm muscles. Note also that the muscles around the armpit are flexed to prevent a rebounding or flying backward of the arm and shoulder when the fist hits the target.

9. Power can be concentrated only when the hips, chest, shoulders, arms, wrists, and fists are firmly linked, and all necessary muscles function fully. If, during a thrust punch, the shoulder is raised or moved forward in advance of the movement of the body, you will be enabled to tighten the muscles at the side of the chest fully. Even if the arm muscles are tensed, the reaction of the impact will cause your punch to rebound off the target.

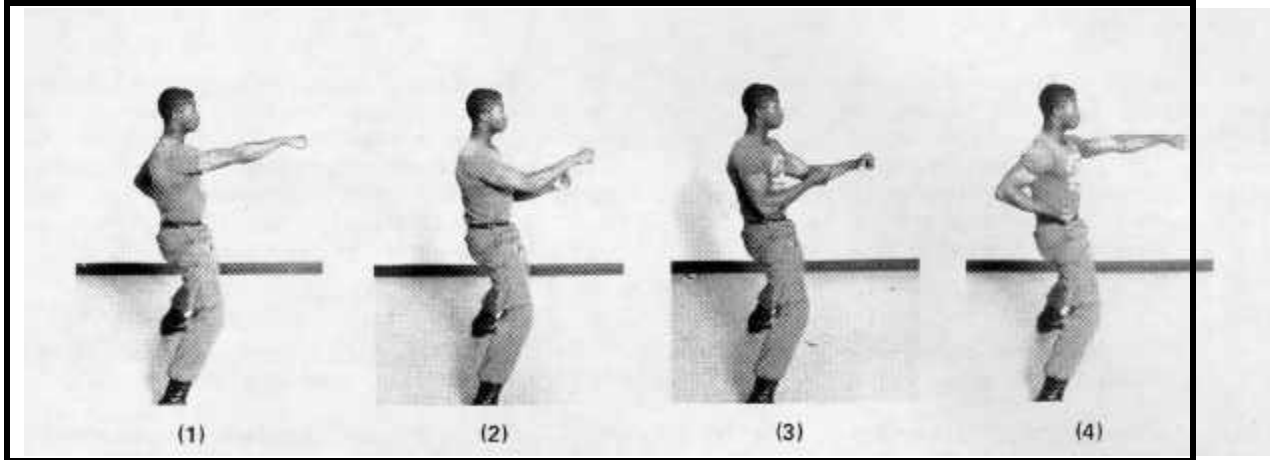

Figure 4-4 Sequence of Delivering a Thrust Punch

TRAINING METHOD FOR BASIC STRAIGHT PUNCH

10. Assume open leg stance of natural position, facing forward. Relax the shoulders and arms, and keep the hands at the sides.
11. Raise the left hand to the height of the solar plexus, palm open and down, and formed as if about to grasp something. Bring the right hand to the side above the hip and form a fist, drawing the elbow to the rear. It is very important in this position to draw the right hand back fully.
12. Withdraw the left hand to the side, closing the hand and forming a fist. It must take the same position above the left hip which the right hand had above the right hip. Simultaneously, drive the right hand forward at top speed along the most direct line to the target. Rotate the forearm so that the back of the fist faces up, and strike the target with a straight punch.

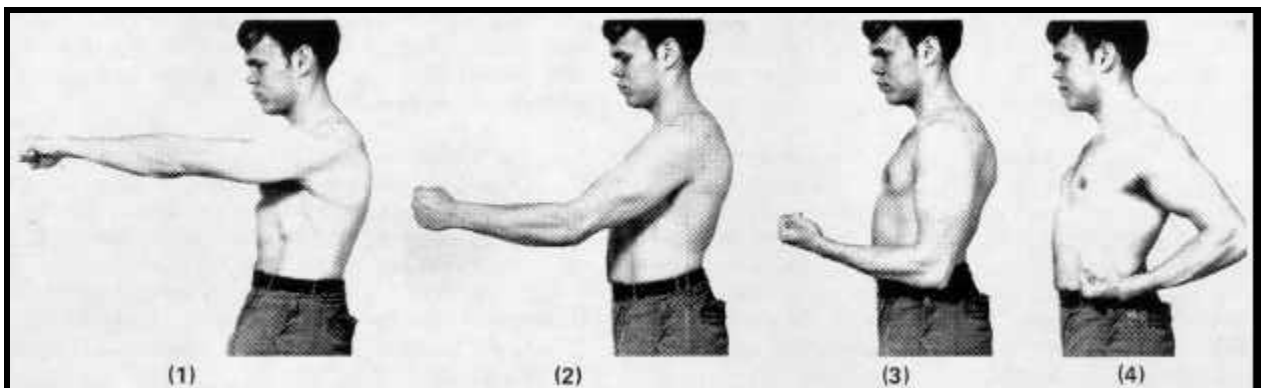

Figure 4-5 Straight Punch

13. Open the right hand and relax. Assume the same position as before, but with the hands reversed. Repeat the movement shown on the next page, punching with the left and withdrawing the right hand to its place above the hip. After practicing this movement, the soldier should be able to relax the body without opening the hand after each punch.

14. **Points to Remember -**

- a. Keep the upper body perpendicular to the ground. Do not lean forward.
- b. Form straight punch correctly and firmly.
- c. Be sure the punch travels to the target along the most direct route.
- d. When withdrawing the hand to the side, pull it back as if to hit the hip. Withdraw the hand with maximum speed.
- e. Keep the shoulders relaxed and in a natural position. There is a tendency for the shoulders to rise or for one shoulder to move ahead of the other. If shoulder is raised, hand will travel an incorrect course to target (see Figure 4-6).
- f. Tense the abdominal muscles properly.

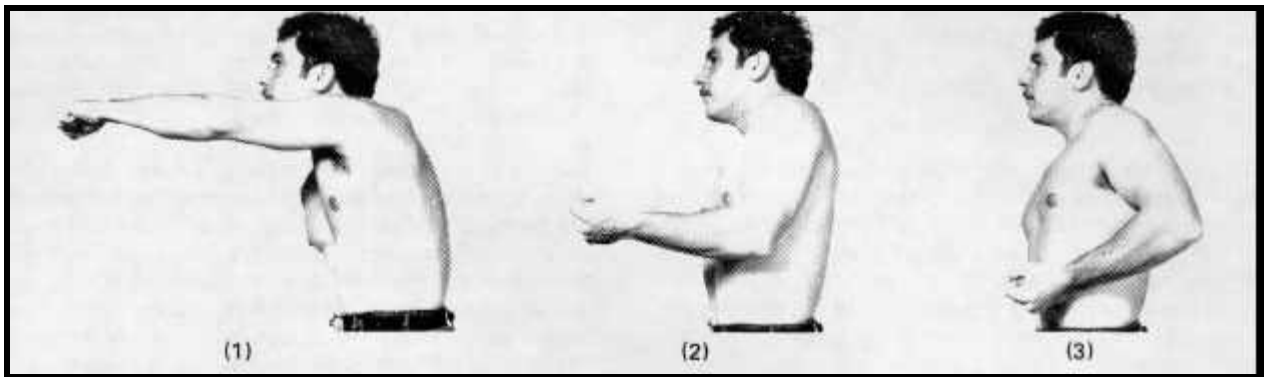

Figure 4-6 Straight Punch - Shoulder Raised Too High



Figure 4-7 Straight Punch - Follow-Through

THE REVERSE PUNCH

15. The Reverse Punch is delivered from a strong, stable stance, and can give a powerful shock to the target. Rotate the hips, keeping them at the same level during the turn. Straighten the rear leg and shift the centre of gravity slightly forward. Imagine that you are pushing the hipbones forward as you turn. The blow will be ineffective if the centre of gravity is too far to the rear at the finish of the movement.

16. This punch begins with the rotation of the hips. The power of this hip movement is transmitted to the chest, shoulder, arm and fist, and culminates in a strong shock on the target. However, to prevent any loss of power, be sure the bodily reaction results from the impact of the fist and hips. If the body is not tensed at the moment of impact, the consequent reaction will reduce impact power. Therefore, the hips, chest, shoulder, arms, and hands must form one solid mass at the moment of contact. To achieve this effect, all the muscles necessary for reverse punch must work together harmoniously and tense powerfully at the same instant.

17. In conclusion, remember that the hips play a leading role in the performance of the reverse punch. Practice this punch and learn how the hip movement forms the basis for the movement of the upper body.



Figure 4-8 Start Position for Reverse Punch

TRAINING METHOD FOR REVERSE PUNCH

18. Assume the left front fighting stance. Relax the upper body. Keep the knee of the rear leg slightly bent and flexible. Extend the left arm with the hand at the height of the solar plexus, palm downward and open as if to grasp something. Place the right fist at the side with the elbow drawn back. Face forward.
19. Withdraw the left hand and simultaneously rotate the hips on a plane parallel with the ground. At the same time, straighten the knee of the rear leg, thrust the foot hard against the ground, and drive the right fist forward to the target.
20. Return the right fist to its initial place above the hip, turning the hips clockwise, and resume the original position.

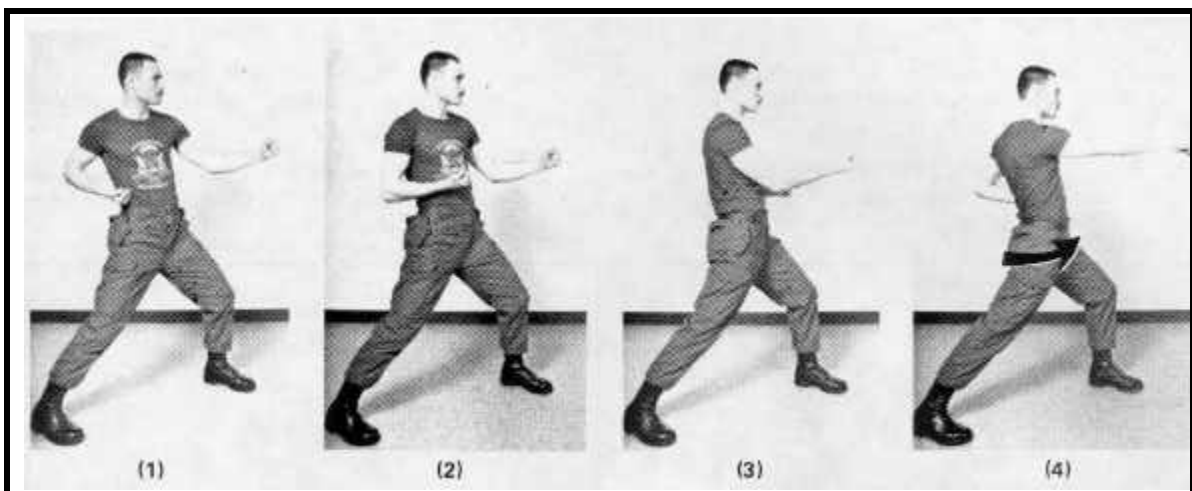

Figure 4-9 Reverse Punch

21. **Points to Remember -**

- a. During the movement the hips tend to rise. Keep the hips down and the soles of the feet firmly on the ground.
- b. When punching, the elbow of the striking arm is liable to leave the side, causing the hand to travel to the target over an incorrect route. Ensure that your elbow brushes lightly against your side as you punch.
- c. The shoulder is liable to move in advance of the hip, reducing the amount of power transmitted to the punching arm by the hip rotation. Relax the shoulder and deliver the punch with the power generated by the turn of the hips alone.
- d. Move the arms and the body in the following order. Remember that both hands move simultaneously.

Withdrawing Hand

Hand - Arm - Shoulder - Chest - HIPS

Punching Hand

HIPS - Chest - Shoulder - Arm - Hand

- e. At the moment of impact the shoulder on the punching side may have advanced too far ahead of the hip. Because of this excessive shoulder movement, the muscles of the side and back cannot be tensed, resulting in an ineffective technique.
- f. The turn of the hips must be quick and sharp. The faster this can be performed, the better.
- g. There is a tendency for the upper body to lean forward at the moment of impact. Avoid this incorrect position.



Figure 4-10 Knee of Rear Leg is Depressed and Heel Raised

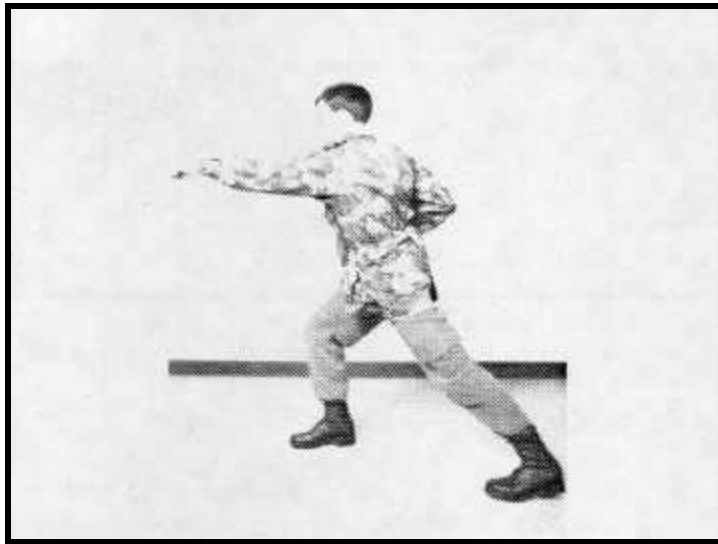

Figure 4-11 Right Hip is Left Behind and Upper Body Leans Forward



Figure 4-12 Upper Body Leans to Right

EFFECT OF STANCE ON ATTACKING RANGE IN REVERSE PUNCH

22. To extend the range of an attack, widen the distance between the feet and lower the hips. For example, an attack from the front stance with the hips relatively high and the feet only narrowly separated would achieve only a short range. An attempt to increase this range by leaning forward would result in loss of stability and an ineffective attack. Instead, widen the distance between the feet by stepping farther in the direction of the target with the front foot and lowering the hips.

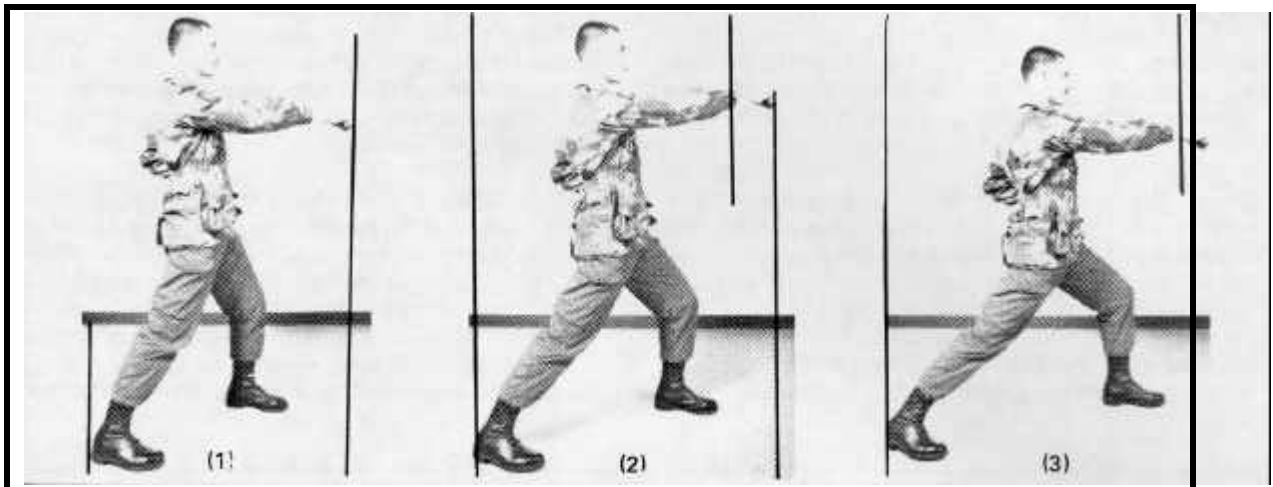

Figure 4-13 Stance

23. Figure 4-13 illustrates the effect on attacking range of changes in foot position and height of hips. Note that greater range is achieved by moving the front foot in the direction of the target while keeping the rear foot stationary.

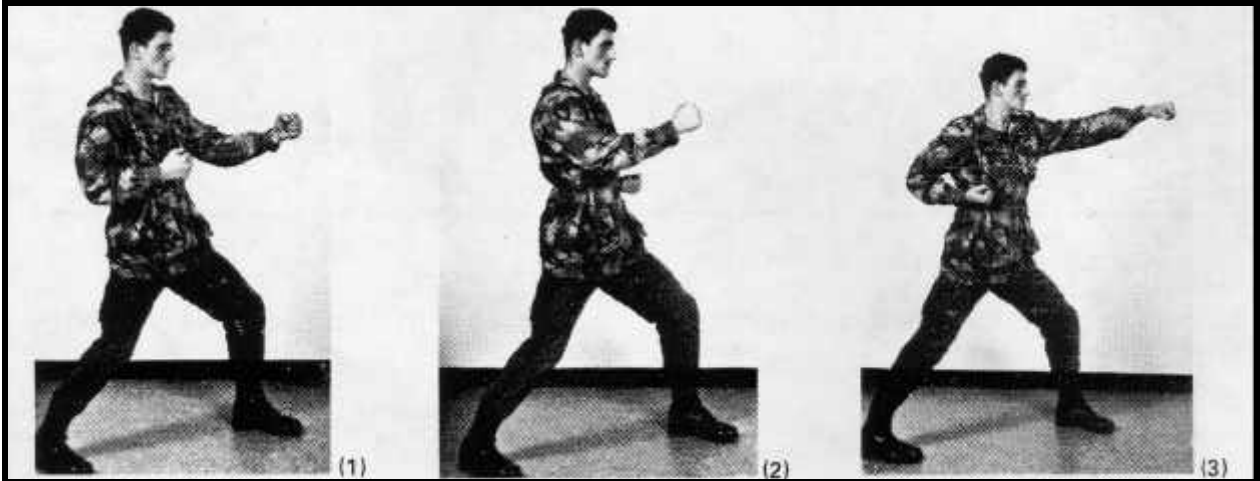

Figure 4-14 Lunge Punch (Side View)

24. If moving the foot forward does not bring the target within range of the fist, do not lean forward to make up the remaining space. Instead, attack with the foot.

LUNGE PUNCH - GENERAL

25. Lunge Punch is a punch delivered at the end of a long forward step. In this movement the centre of gravity undergoes a big shift. The forward momentum of the body gives additional force to the lunge punch, resulting in a more powerful blow than is possible by a reverse punch.

26. To perform the lunge punch, step forward with the rear foot from left-front stance to right-front stance. At the same time, attack the face area or chest area with the front stance of the same side of the body as the advancing foot. For example, if you step forward with the right foot, attack with the right hand.

27. If you fail to step forward quickly, the opponent may anticipate your attack and apply a counter, or sweep your advancing foot and upset your balance. To prevent this, push the hips forward strongly by driving the supporting foot hard against the ground as you move ahead. Do not raise the heel of the advancing foot, but slide the foot over the floor. Attempt to move forward as smoothly and rapidly as possible.



Figure 4-15 Lunge Punch (Front View)

IMPORTANT CONSIDERATIONS IN LUNGE PUNCH

28. When advancing the rear foot, first draw it close to the supporting foot and then step outward and slightly to the side, describing a kind of semicircle. Slide the foot lightly over the floor as it moves forward.

29. As you begin your advance, move the hips forward until they are over the supporting leg. At this point the entire weight will be supported by one leg. As you continue to move forward, drive your supporting leg toward the ground and use the resulting reaction to propel your hips forward.

30. Keep your body turned off until the moment your entire weight rests on the supporting leg.

31. Drive your arm forward at the same instant as you begin to rotate your hips to their terminal position. End the movement of the feet, hips and arms simultaneously.

32. Attempt to convey to the punching arm every possible ounce of power generated by the reaction of the supporting leg against the floor.

33. In theory, loss of power is minimized when the upper body leans forward at an angle such that the supporting leg and the punching arm are permitted to thrust in opposite directions along the same plane. Considerations such as stability and the nature of the technique to follow prevent assuming this forward lean. However, lowering the hips as much as possible also keeps power loss to a minimum because at the moment of impact this action serves to reduce the size of the angle between the rear supporting leg and the floor, and produces greater power along the horizontal plane. Therefore, lower your hips to produce maximum power.

34. Be sure to thrust your hips in the same direction taken by your punch. In other words, move your centre of gravity toward the target.
35. Make full use of the power created by the rotation and forward thrust of your hips.
36. During the course of the movement, prevent your body from bobbing up and down by moving your hips forward along a straight line parallel to the ground.

TRAINING METHOD FOR LUNGE PUNCH

37. Assume the natural position, open-leg stance. Raise the left hand palm open, in front of the body at about the solar plexus. Form a fist with the right hand and place it above the right hip with the back of the fist toward the ground.
38. Slide the right foot one step forward and assume the right-front stance.
39. As you slide forward, withdraw the left hand above the left hip, forming a fist with the back of the hand facing downward. Simultaneously, thrust the right fist forward, turning the forearm 180 degrees until the back of the fist faces up.
40. Withdraw the right foot and return to the original position.
41. Practice the foregoing movements on the opposite side, sliding the left foot one step forward to the left-front stance and punching with the left hand.
42. Return to the original position.
43. Practice these movements, alternating from side to side.
44. **Important considerations in the Lunge Punch -**
 - a. The forward movement of your foot must be smooth. Make it light and fast. Also, move forward quickly and smoothly to correspond with your step.
 - b. Do not lean forward or allow the shoulder to precede the body. Keep the upper body perpendicular to the ground and the hips and shoulders directed forward. Deliver the punch with the hips instead of with the shoulder or arm alone.
 - c. Straighten the knee of the rear leg, and flex the muscles of the leg, body, and arm at the moment of impact.

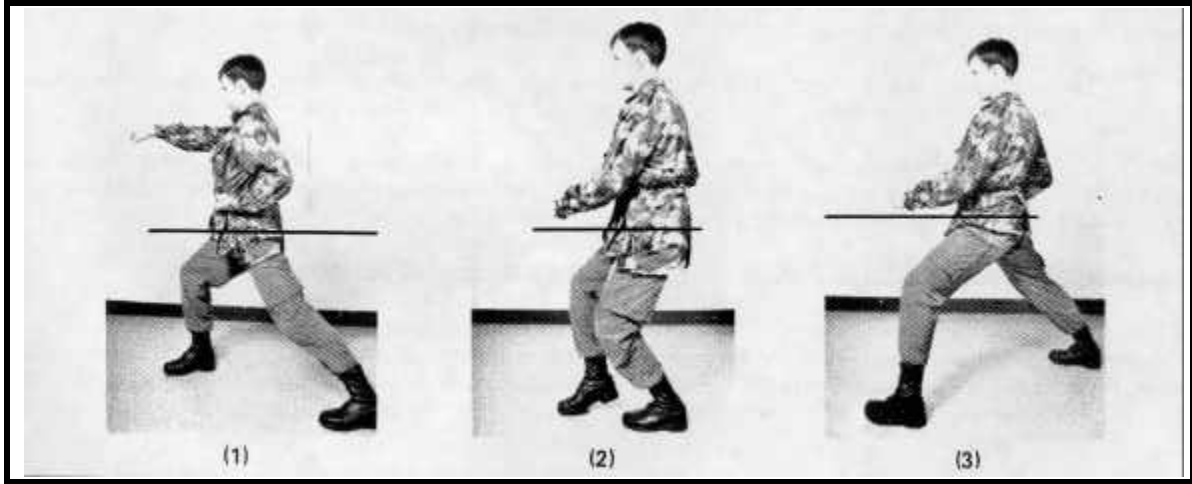

Figure 4-16 Lunge Punch - Training Method

CHAPTER 5

KICKS

KICKING THEORY AND PRACTICE

1. Kicking includes some of the most powerful techniques in unarmed combat. If sufficiently mastered, kicking techniques can have a more powerful effect than attacks with the hands. However, mastering kicking techniques requires much time and effort.
2. **Good Balance.** When kicking, good balance is of primary importance because the body weight is supported by only one leg. This situation is aggravated at the instant the foot hits the target by the strong counter shock of the kick. To counteract this shock, place the supporting foot firmly on the ground and fully tighten the ankle of the supporting leg. Attempt to absorb the shock with the ankle, knee and hip of the supporting leg, and keep the upper body well balanced and perpendicular to the ground.
3. **Whole Body.** To achieve maximum effect, kick with the whole body instead of with the leg alone. Pushing the hips forward during the kick helps achieve this goal.
4. Be sure to withdraw your kicking foot quickly after completing the kick. This prevents the opponent from catching it or from sweeping your supporting leg. As soon as the foot is withdrawn it must be ready for the next attack.
5. **There are two ways of kicking.** The first is done with a snapping and upward movement of the foot. The second by straightening the knee and thrusting the foot outward and downward while stepping toward the target.

FACTORS IN KICKING

6. Bend the knee of the kicking leg to its maximum extent. Begin by raising the knee of the kicking leg as high as possible and bending the knee fully. This action is an important preliminary to kicking, comparable to the run before the take-off in broad or high jumping. Practice in lifting the knee also helps accustom the body to balancing on one leg, and aids in learning the first part of the correct course of a kicking foot.
7. Part of the reason for bending the knee fully is to keep the weight of the kicking leg as close as possible to the trunk. The kick has greater power if the leg is initially close to the body. By bending the knee fully, better leverage is obtained to make a quick and powerful kick.
8. During the kick, keep the supporting leg steady, with the knee slightly bent. If the knee is bent too much is an effort to keep the hips low, the muscles of the leg will support the body with difficulty. The knee and ankle will be loose, and it will be difficult to kick effectively. Be sure to bend the knee only slightly, lean the leg slightly forward, tense the muscles of the leg, and keep the sole of the foot firmly in contact with the ground.

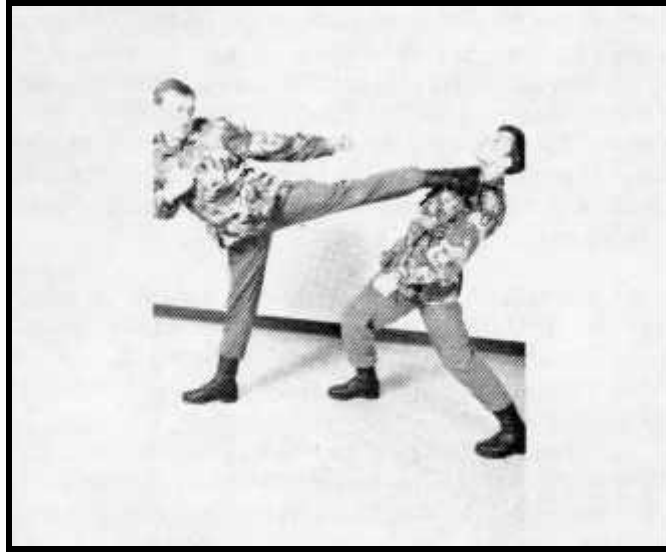

Figure 5-1 The Kick

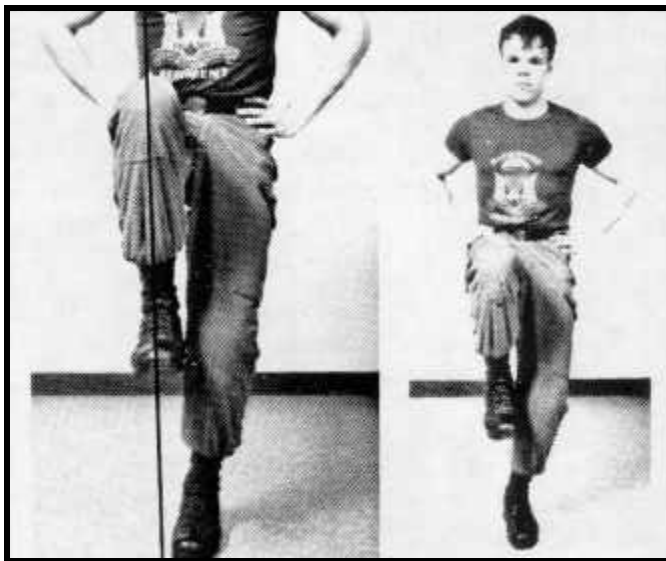

Figure 5-2 Leg Position in Preparation for the Kick (Front View)

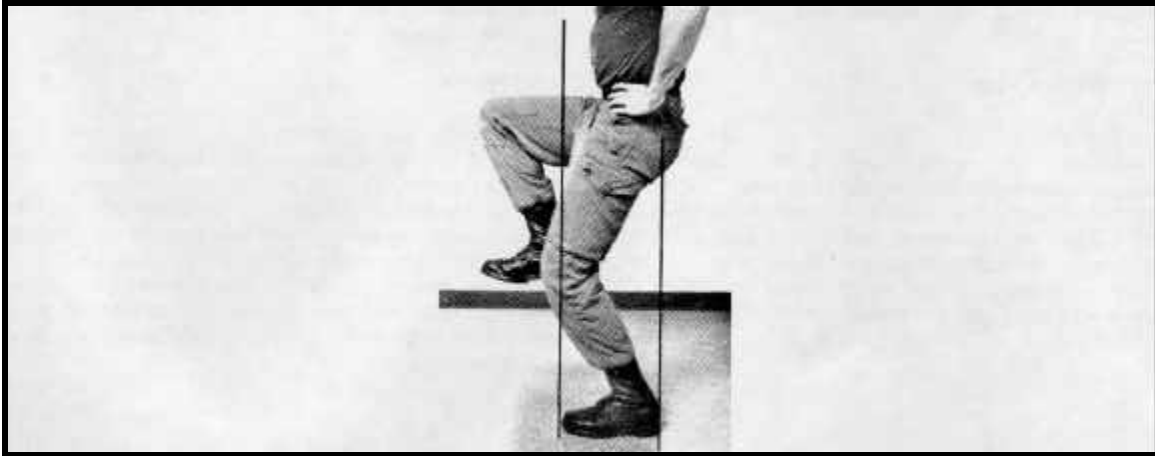

Figure 5-3 Leg Position in Preparation for the Kick (Side View)

IMPORTANT POINTS IN RAISING AND BENDING THE KNEE

9. Raise the knee, keeping the sole of the foot parallel to the ground, but with the ball of the foot slightly higher than the heel.
10. Keep the shin almost perpendicular to the ground.
11. Pull back the heel as much as possible. A plum line dropped from the knee should hit a point at the tips of the toes.
12. Point the knee and toes in the same direction.
13. Turn the toes up and tighten the ankle.
14. Relax the knee joint and keep it flexible, ready for the next movement.

SNAP KICK

15. Deliver the snap kick with a strong snapping motion, beginning from the raised and bent knee position of the leg described above. The foot describes almost a half circle during the kick.
16. In the snap kick, balance is often poor because of the restricted base provided by the supporting foot, and because the power of the kick is usually directed upward. Return as quickly as possible to a somewhat wider stance, with both feet on the ground. Maximum speed is essential in the execution of the snap kick, or, for that matter, any kick. A slow snap kick not only fails to create a powerful attack on the target, but results in an unbalanced position.

17. To deliver the snap kick, raise and fully bend the knee and then quickly and powerfully tense the muscles at the front of the thigh. This tension drives the foot outward. When the leg is fully extended, relax the muscles at the front of the thigh and tense those at the back. This action withdraws the foot.

18. The kick from beginning to end is very smooth, and there is no noticeable pause at the moment of impact. This is because the muscles at the back of the thigh are stretched as the leg is extended outward. A sudden release of tension in the front thigh muscles will immediately cause those at the back to contract, automatically withdrawing the foot.

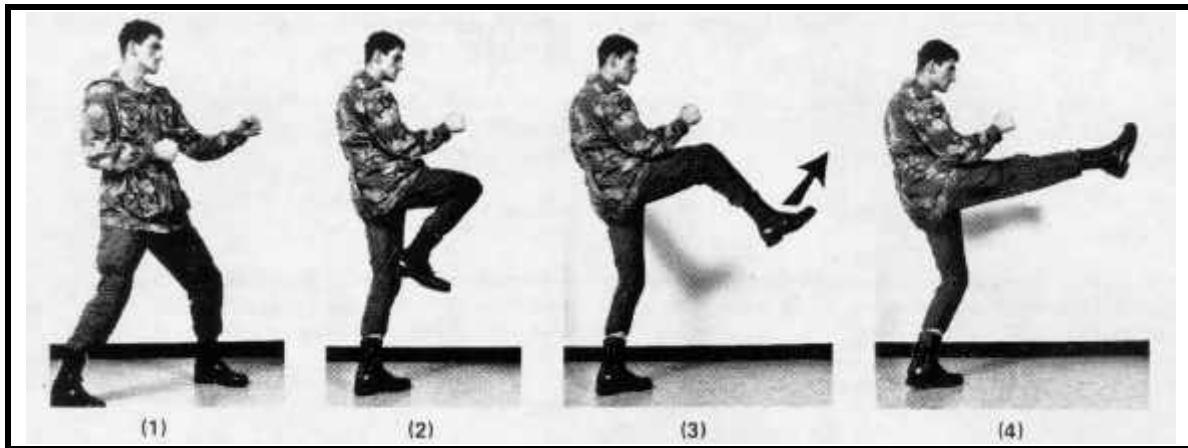

Figure 5-4 Snap Kick

19. **Important Points -**

- a. If you are too intent on kicking, the knee joint of the kicking leg will tense, preventing a smooth movement. Relax the knee, raise the toes, and tense the foot.
- b. After kicking the target, withdraw the foot fully to a position beside the knee of the supporting leg.
- c. Concentrate all your power at the ball of the foot at the moment of impact. At the same time, push the hips in the direction of the kick.

THRUST KICK

20. From the raised and bent knee position described above, a thrust kick can be aimed directly ahead or directly to the side. It can hit a target located at knee height, at waist height, or higher.

21. As in the case of a straight punch with the hand, be sure the foot travels the most direct course to the target. Keep the movement light and fast at the start of the kick, but concentrate maximum power in that foot at the moment of impact. The thrust kick is more difficult than it appears to be. You must correctly judge the distance separating you from your opponent, or your kick will fail.

22. Thus, a successful thrust kick depends upon correct distancing and split second timing. The foot must hit the target at the moment the leg is fully extended and exerting maximum power. If the foot hits the target too soon or too late, the resulting reaction will push the foot back toward the kicker instead of striking the target. This negative reaction is greatest when the foot hits the target with the leg already fully extended but improperly focused.

This adverse reaction is more likely to destroy your balance when you kick waist high than when you kick at a downward angle. Remember the importance of distancing and timing in thrust kicks.

23. **Important Points -**

- a. Flex the ankle and knee of the supporting leg.
- b. Lean the upper body as much as possible in the direction of the kick. If you lean away from the kick, you will lose your balance. At worst, you will be propelled away from the target at the moment of impact.
- c. Utilize the hips. Push them in the direction of the kick.

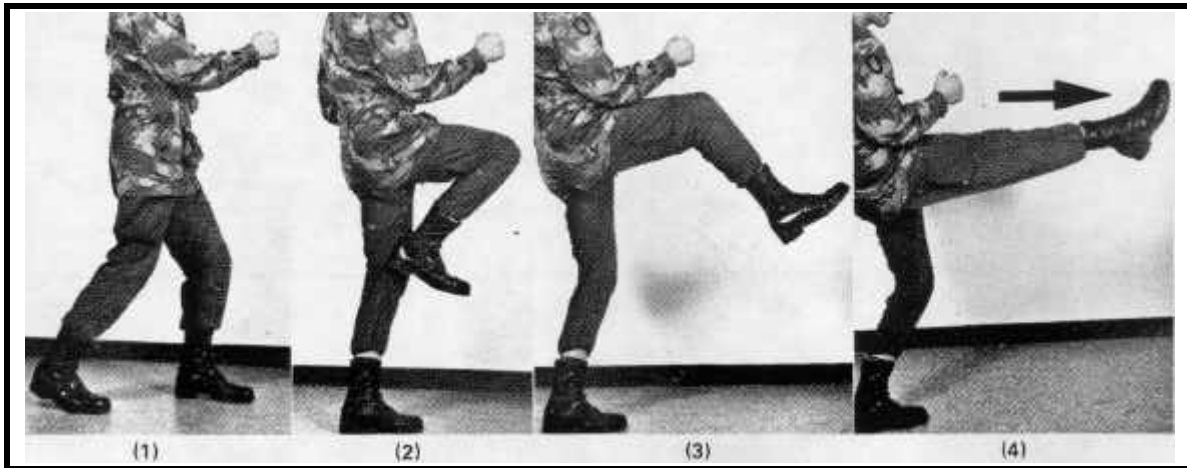

Figure 5-5 Thrust Kick

24. **Points to Remember -**

- a. Your hips tend to rise when you snap kick with the rear leg. Therefore, do not straighten the knee of the supporting leg, and keep the hips on the same horizontal plane throughout the kick.
- b. If your hips remain behind and your upper body leans forward during the kick, the range of the kick will be reduced and its effectiveness correspondingly lowered. Therefore, move the hips forward as quickly as possible at the start, and maintain good balance with the supporting leg.
- c. If the upper body is unbalanced, it is impossible to kick effectively. Therefore, tighten the muscles of the lower abdomen to maintain a tight connection between the upper and lower parts of the body.
- d. After kicking, the next position of the kicking foot on the ground varies. However, in almost all cases, this foot must first return to a position close to the knee of the supporting leg to expedite its movement onto the ground. An exception occurs when the kicking foot is not withdrawn, but slides down the opponent's body to the ground as either hand continues the attack. In general, the next position of the kicking foot depends on distance from the opponent, posture, and on the nature of the following techniques.
- e. Keep the heel of the supporting foot firmly on the ground. If the heel rises, balance will be momentarily weakened, increasing the time necessary to shift to the next movement.
- f. Ensure that the foot takes the shortest and straightest course in its route to the target. The rear-leg kick is most effective when the target is directly ahead.

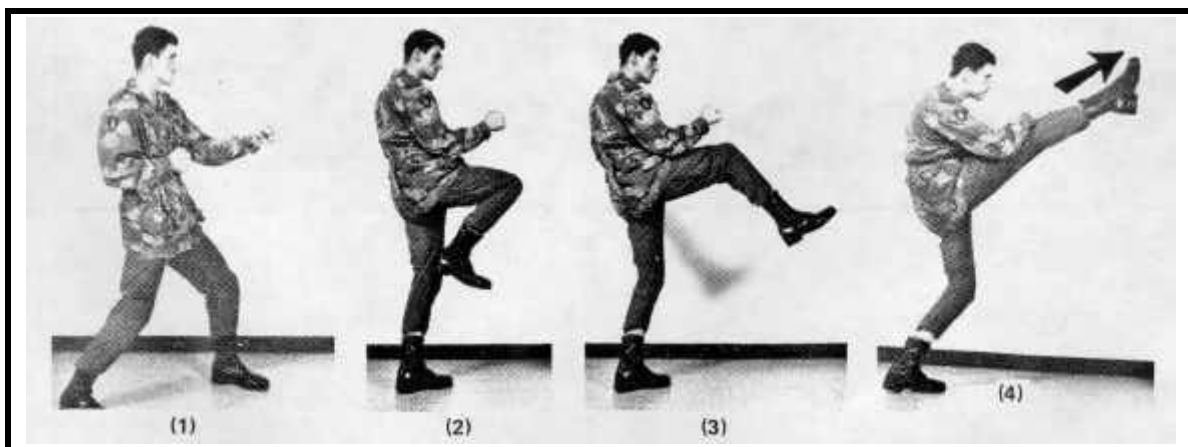

Figure 5-6 Thrust Kick to Head

REAR LEG KICK TRAINING METHOD

25. Assume the left-front stance with the fists at the sides. In the case of beginners, it is better to place the hands on the hips.
26. Without moving the supporting foot, and keeping the knee bent, move the hips forward until the weight is entirely supported by the left leg. Simultaneously, raise and bend the knee of the kicking leg so that the foot moves past the knee of the supporting leg.
27. Continue the movement by snapping the right foot back to the target.
28. Immediately, or reflexively, snap the foot back to a position next to the knee of the supporting leg.
29. Continue the movement and return to the start position. Repeat the above practice alternately on both sides of the body.
30. Note difference when hips are thrust forward (see Figure 5-7) and when body leans forward (see Figure 5-8).

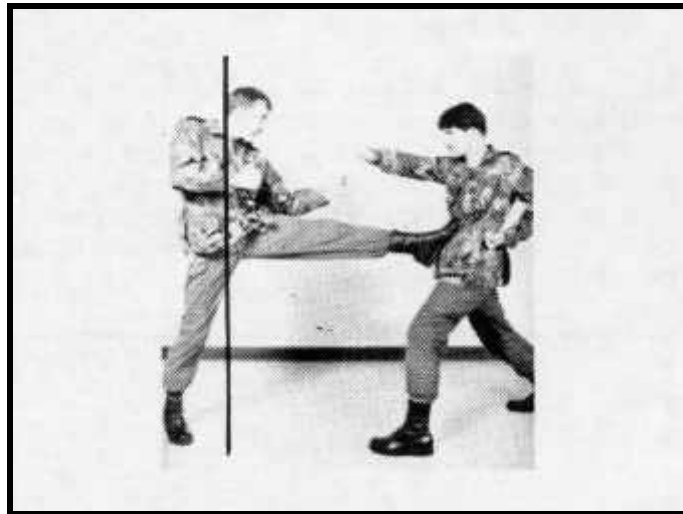

Figure 5-7 Rear Leg Kick



Figure 5-8 Rear Leg Kick - Leaning Too Far Forward

31. **Important Considerations -**

- a. Push the hips forward when kicking. If the hips are permitted to remain behind, the upper body will lean too far forward and bring the face within range of the opponent's attack (see figures).
- b. Keep the hips low to increase stability. However, if they are too low, the knee of the supporting leg will sink during the kick, reducing stability and shortening the kicking range. Bend the knee of the supporting leg enough to allow a plumb line from the knee to fall at a point just at the tips of the toes.
- c. When kicking, point the knee of the supporting leg in the direction of the target. Failure to do this causes the kicking foot to stray from the target, and prevents the concentration of maximum power at the moment of impact. Ensure that the knee of the supporting leg is flexed and that it and the toes of the supporting foot point directly at the target.

FRONT KICK BODY POSITION

32. In Figure 5-9 the centre of gravity falls within the base area of the supporting foot. This condition contributes to good balance. There is little chance here to add the forward momentum of the body to the strength of the kick.

33. A large upward snapping kick is possible from this position, and it enables you to meet the opponent's counter-attack, or to deal adequately with any other change in the situation.

34. Although, in Figure 5-10, the centre of gravity falls outside the base area of the supporting foot, good balance is still possible. Forward body momentum can strengthen your kick. The foot can easily snap outward and upward toward the target. Moreover, the kicking range is extended.

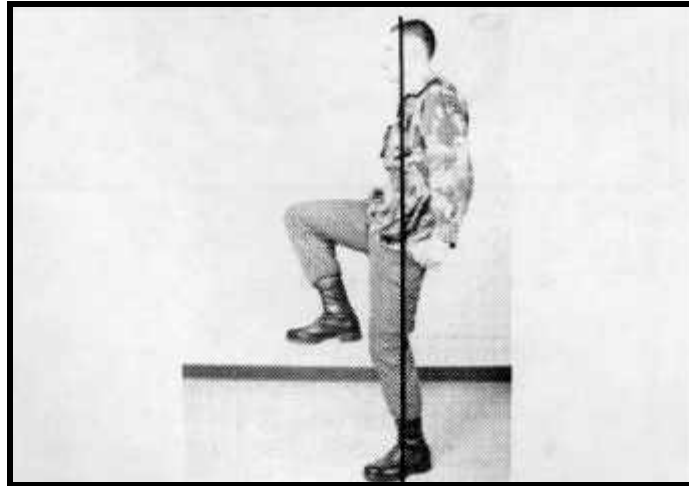

Figure 5-9 Front Kick Body Position

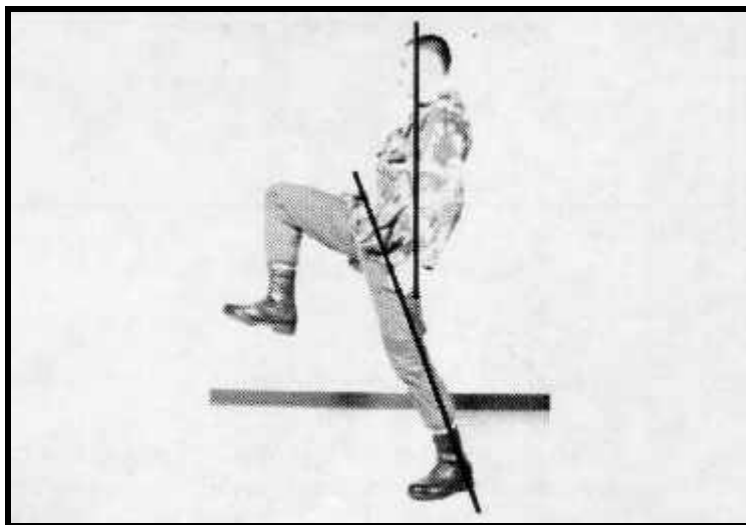

Figure 5-10 Front Kick Body Position - Leaning Forward

35. After kicking the target, you can place the kicking foot on the ground in front of the supporting foot, thereby easily maintaining your balance. If necessary, it is also possible to return the kicking foot to its initial position on the ground without upsetting your balance.

36. As in Figure 5-9, you can easily cope with the opponent's counter-attack, or adjust to any change in the situation. In Figure 5-11, the centre of gravity falls rather far outside the supporting base area. This situation makes for poor balance. The driving power of the

body can be utilized here, but because the hips are behind the shoulders, it will be difficult to impart a powerful snap to the kick.

37. After kicking, you must set your foot down in front of the supporting foot. There is no chance to withdraw the foot and to resume your initial position.

38. Because the body leans forward, it will prove difficult to deal with the opponent's attack. A kick from this position generally gives the opponent an opportunity to attack your face with a punch.

BACK KICK

39. Back kick is a kind of side thrust kick. It can be aimed directly behind or directly to one side. It can hit a target located at knee height, waist height or higher. The heel is used as the striking surface.

40. To perform a back kick bring the heel of the striking leg up to the knee of the supported leg. Look over the shoulder of the leg in which you are striking. Keeping the knee as high as possible, kick out to the rear in a straight line.

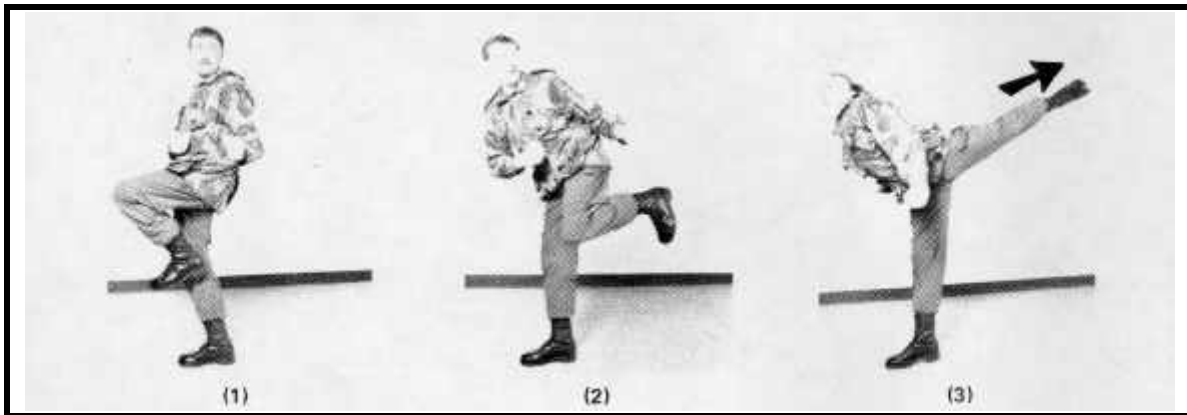

Figure 5-11 Back Kick Sequence

STAMPING KICK

41. Stamping Kick is very effective when directed against the opponent's knee, instep or face. To increase kicking power, shift your weight onto the kicking leg as you stamp downward.

42. Use the stamping kick to escape from an opponent who has thrown his arms around you from the rear. These kicks also serve as preliminary feints to some decisive attack. They are also most effective once your opponent is on the ground.

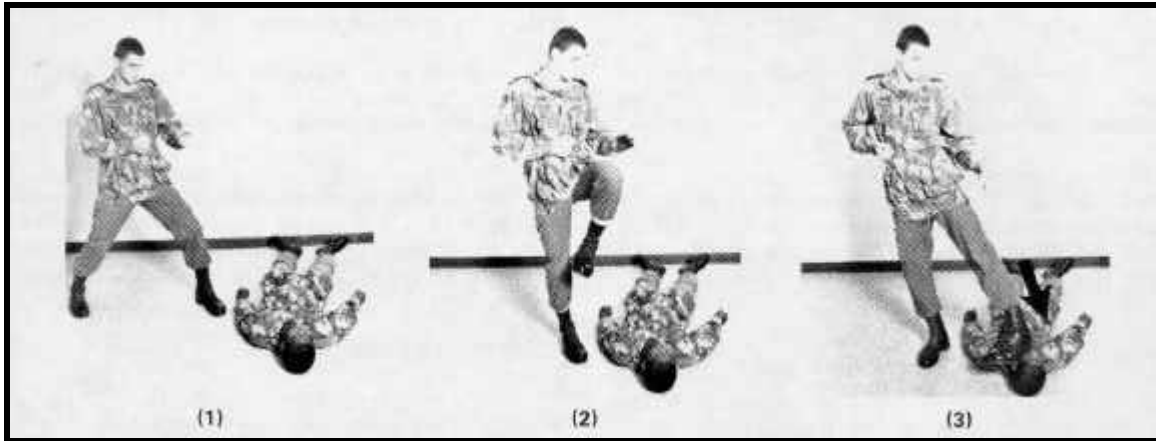

Figure 5-12 Stamping Kick

FOOT SWEEP

43. The foot sweep is a round house or hooking kick delivered at the opponent's ankle. This technique is used to upset your opponent's balance for further attacks (see Figures 5-13 through 5-15).



Figure 5-13 Foot Sweep (Front View)



Figure 5-14 Foot Sweep (Rear View)

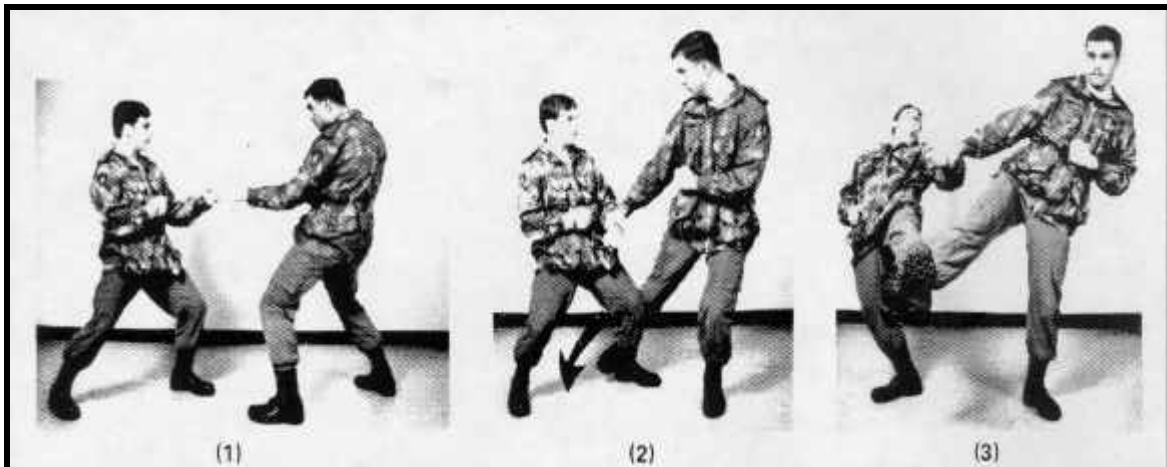

Figure 5-15 Foot Sweep Sequence

CHAPTER 6

BLOCKS

GENERAL

1. Defence against an attack is a more complicated process than it appears at first glance. To begin with, you must anticipate the nature and direction of your opponent's attack before blocking it. Also, while blocking, you must attempt to seize the initiative and turn the opponent's attack to your advantage.



Figure 6-1 Blocking

2. The following methods illustrate the various possibilities in blocking:
- a. Block the opponent's arm or leg with sufficient force to discourage further attack. In a sense, this kind of block can be called an attack.
 - b. Block the opponent's attack with only enough force to parry or deflect it. This would be termed a light block.
 - c. Block and attack. Block the opponent's attack and immediately counter-attack. Block it also possible to block and counter-attack at the same instant.
 - d. Unbalance the opponent with your block.

- e. Block the opponent's attack as it is about to begin. To do this you must anticipate his attack.
- f. Block and then retreat to a safe position until a chance to counter presents itself.

FACTOR 1 - DIRECTION OF POWER IN THE BLOCK

3. First, correctly judge the path of the opponent's attack. Then, change the direction of his attack by blocking. Basically, blocks should be directed along these general routes:

- a. Against an attack to the face, block from the underneath upward.
- b. Against an attack to the midsection, block from the outside inward or vice versa.
- c. Against an attack against the groin area or lower, block downward and sweep to the side.

4. A block that lacks definite direction will usually fail. The principles set down above are evident in the following commonly used blocks.

5. **Upper Block (against a head attack).** Move the blocking arm from its starting position upward and forward until it contacts the opponent's arm. At the moment of contact, bring your forearm back toward your head, ending in a position directly in front of your forehead. In its complete course the blocking arm describes a curve. Note that its route lies outside the withdrawing arm. If you are greatly superior to your opponent in strength and skill, it is unnecessary to bring your forearm toward your head after blocking. Its path need not curve, but can continue upward and forward. However, under ordinary circumstances it is safer to follow the curve.

6. Move the right forearm upward as the left hand withdraws. The blocking arm's course is outside the left arm. If correctly done, the left hand and right forearm will form a cross in front of the face as they pass one another. Remember to keep the right elbow close to the body at the beginning of the block. The blocking surface in this defence includes about three or four inches of the bony area at the bottom of the wrist.

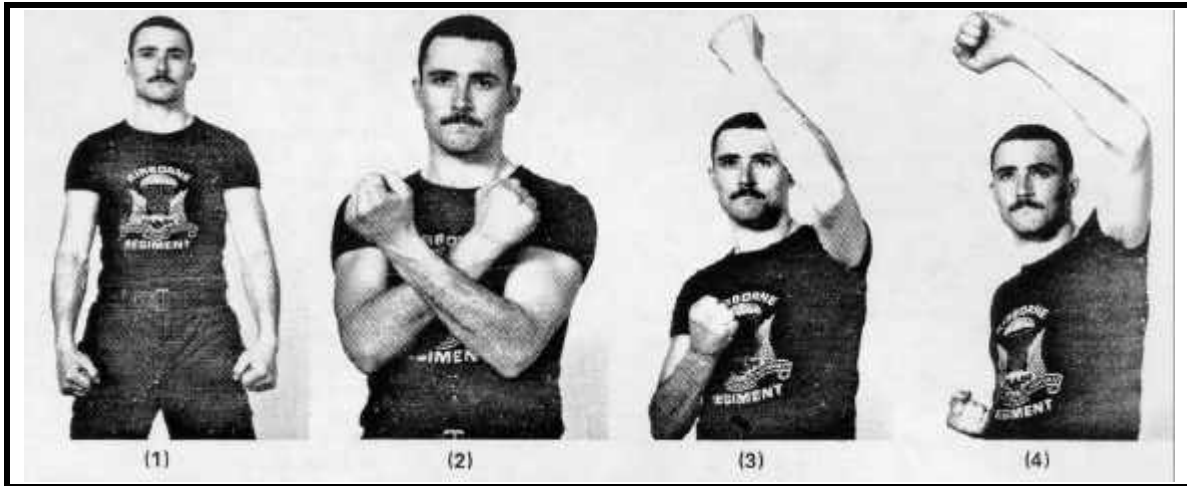

Figure 6-2 Block Against a Head Attack

FACTOR 2 - FOREARM ROTATION AND TIMING

7. **Forearm Rotation.** Blocks gain in power if you rotate the forearm during the delivery. When you block, twist your forearm as though you intended to drive it into the bone of the opponent's arm. This forearm rotation also serves to guide the opponent's attack away from your body.

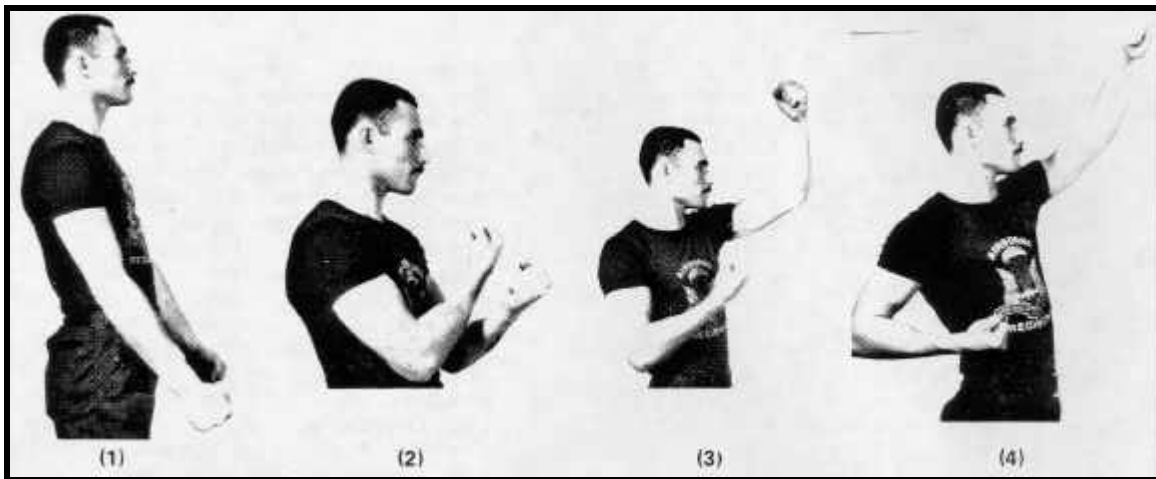

Figure 6-3 Upper Block Against Head Attack

8. TIMING -

- a. Forearm rotation and timing are closely related. Obviously, the block must not be applied too early or too late. Judge the opponent's intent and assume the starting position of your block, but be sure to allow enough time to parry or deflect the attack.

- b. Let us consider the upper block, under ideal conditions, in terms of forearm rotation and timing. Raise and rotate your forearm from the side, and block the opponent's arm upward from below. Contact the attacking arm relatively far from your head before bringing your arm back toward your head. After the initial contact, continue to rotate your forearm to guide the opponent's attack up over your head.
- c. Sometimes the opponent is too close to enable you to block his arm in this manner. In such a situation, quickly raise your forearm straight upward, rotating it rapidly. Because the opportunity to guide the attacking arm away from you is absent, the block must be strong and sharp enough to deflect the attack. Correct timing and arm rotation are essential if the block is to be effective.
- d. Unfortunately, ideal blocking conditions are seldom met. There is usually insufficient time to assume the prescribed starting position. When the attack comes suddenly, move immediately into the final phase of the block from whatever position you may be in.
- e. In the case of an attack directed at your abdomen, you may be confronted with a choice of blocks. Hesitation could prove disastrous, as could the wrong choice. To illustrate, suppose you are in a low position and the opponent attacks your solar plexus, or suppose a taller opponent attacks this point. You are faced with a choice of blocks. If you block with the downward block, first raising your fist to your shoulder, you will have insufficient time for a successful block because your fist will be raised too high. Far better would be the forearm block against a body attack from the outside inward. Attain proficiency in the appropriate block through constant practice.
- f. To have sufficient time and space to enable the blocking arm to achieve somewhere near its full range of movement is not always possible. However, because blocking conditions are usually less than ideal, correct timing becomes extremely important. Gauge the speed of the opponent's attack and his distance from you, and then time your block to deflect his attack.

FACTOR 3 - HIP ROTATION

9. The discussion of punching techniques clearly demonstrated the importance of hip rotation to increase punching power. Hip rotation is also necessary to produce an effective block. Whether your block is to be a strong one, delivered from a solidly based position remember to rotate your hips. It is impossible to parry or deflect a strong attack if you fail to use the power in the hips.

UPPER BLOCK AGAINST HEAD ATTACK

10. End the block with your forearm the distance of one fist in front of your forehead. In this position your forearm should be at an angle to the horizontal. If you block in this way, the opponent's attack will pass over your head. Also, the time spent in blocking is kept to a minimum, compared with a block which does not stop in front of the forehead, but continues further upward. Figure 6-7 illustrates an incorrect position of the blocking arm. The elbow is raised excessively, and balance is impaired. Shifting to the following technique will prove difficult.



Figure 6-4 Preparing to Block



Figure 6-5 Blocking from Inside Outward

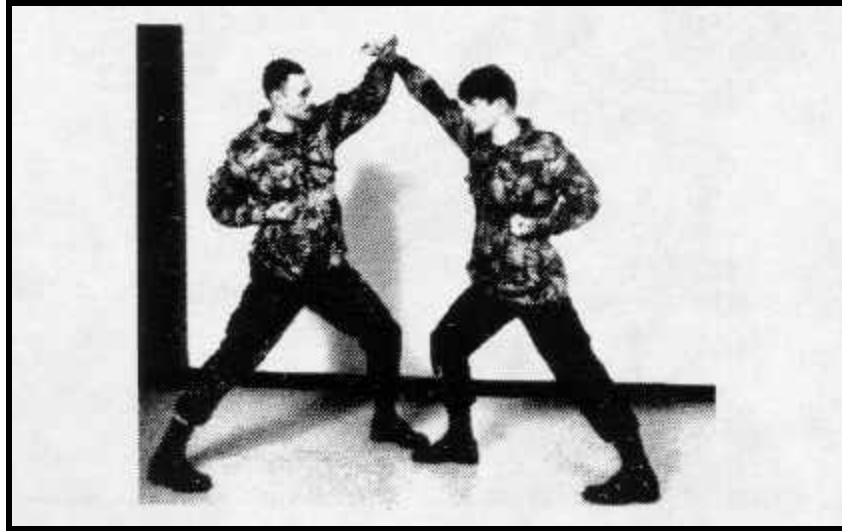

Figure 6-6 Block Outside Inward

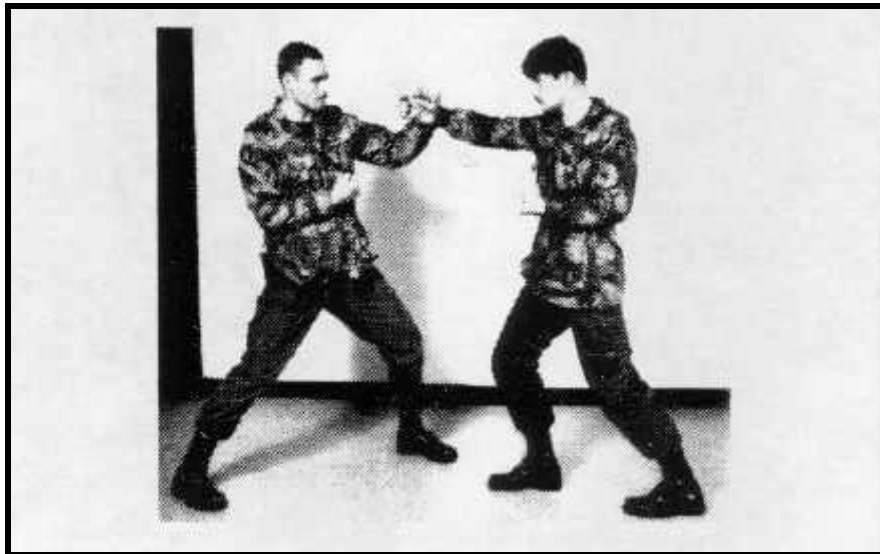

Figure 6-7 Blocking a Thrust to the Head

TRAINING METHOD FOR UPPER BLOCK

11. Assume the open-leg stance.
12. Begin to slide your right foot to the rear and raise your right arm in front of your face. As your foot continues to the rear, withdraw the right hand to your right side and bring your left forearm upward to block. Raise the blocking arm to the outside of the withdrawing arm.

13. At the end of the blocking movement your body should be at fighting stance, your right fist above your right hip, and your left forearm in front of your forehead (see Figures 6-4 to 6-7).

14. Return to your initial position.

15. Practice the above movement alternately on both sides of the body.

16. **Important Considerations -**

- a. If you raise the elbow of your blocking arm too high, the muscles around your armpit cannot tense fully and your block will be weak. Avoid this fault by blocking with your hand higher than your elbow.
- b. If your blocking forearm ends too far in advance of your forehead, the opponent's attack may pass over your block and hit you (see Figures 6-8 and 6-9). Remember that the ideal distance above your forehead is four inches.
- c. Sometimes fear of the impending attack causes students to throw their heads backward to escape the blow. Avoid this reaction.



Figure 6-8 Blocking - Arm Too High



Figure 6-9 Blocking - Arm Too Far From Head

OUTSIDE MIDDLE BLOCK

17. **Direction of Block (against body attack).** Block from outside inward with bottom of wrist. Raise the left arm at the side with the fist near the left ear. At this point the bottom of the fist points outward toward the left. With the elbow bent at 90 degrees, drive the arm downward and forward and block the opponent's punch to your body. At the instant your forearm meets the opponent's arm the back of your fist must face the opponent at the height of your chin, with your forearm almost perpendicular to the ground. Twist the forearm 180 degrees counterclockwise as it travels from outside inward. To summarize, strike the opponent's attacking arm to the side with a circular motion of your forearm from the outside inward. As the upper block technique, the blocking surface of the forearm is the bony area at the bottom of the wrist.

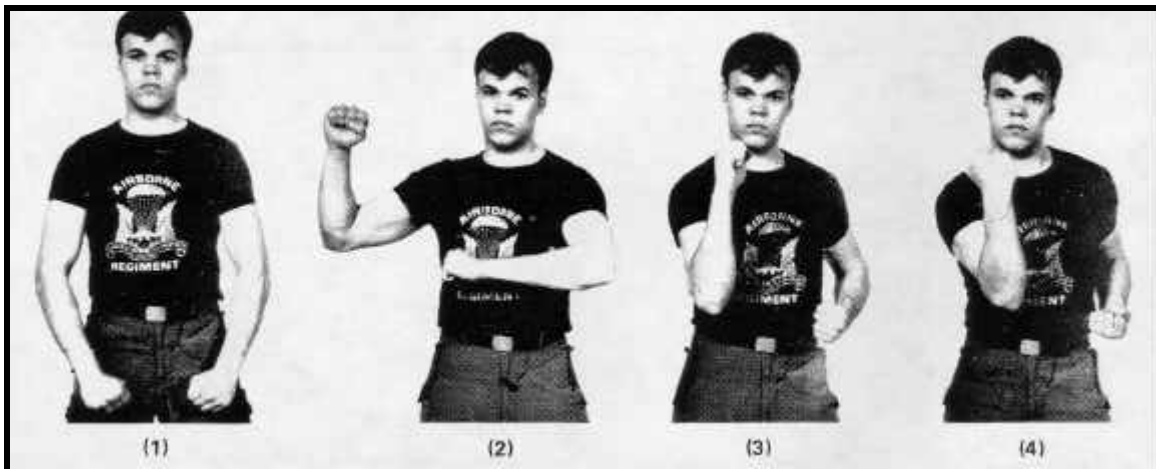

Figure 6-10 Outside Middle Block Sequence

TRAINING METHOD OUTSIDE MIDDLE BLOCK

18. Assume the open-leg stance of the natural position. Let your arms hang naturally at the sides.
19. Begin a backward step with your left foot and extend your left hand (or fist) to the front. Simultaneously, raise your right fist above your right shoulder near the ear.
20. Continue your backward step, withdraw the left hand to the left side, and rotate the hips counterclockwise. At the same time, drive the right forearm forward from the outside inward against the imaginary attacking arm.
21. End the entire blocking movement with your body in the right-front stance at fighting stance. At this moment your left fist should be over your left hip with the back of the fist directed down, and your right fist should be in front of your body at chin height.
22. Step forward with the left foot and return to the natural position.
23. Practice this blocking technique on the other side of your body by blocking with your left arm. Finally, repeat the movement alternately on both sides. Instead of stepping to the rear when blocking, practice also while stepping forward. In addition, necessary training includes applying the block after shifting from stance to stance.

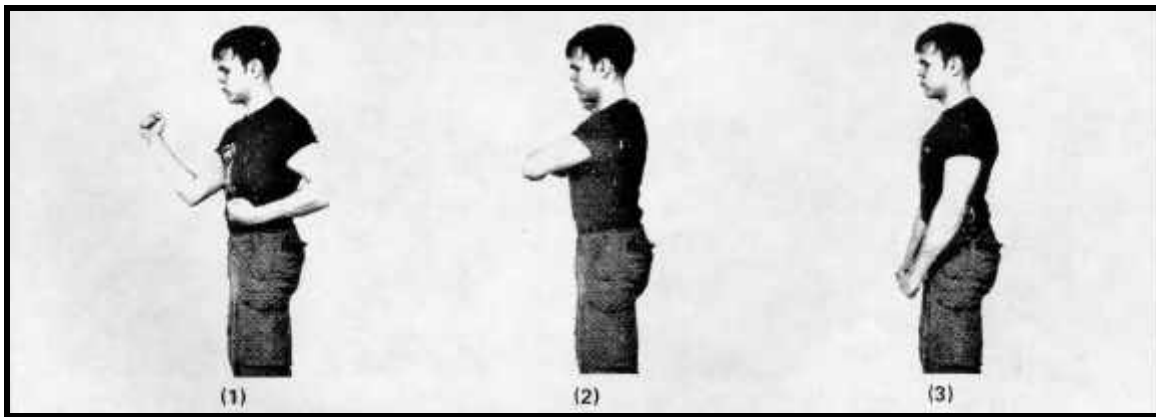

Figure 6-11 Training Method Outside Middle Block

24. **Special Considerations -**
 - a. Rotate your hips strongly. The faster the hips rotate, the greater the strength they impart to the block. Increase the speed of your hip rotation by powerfully withdrawing your non-blocking arm. Avoid rotating only your shoulders when it is necessary to rotate your hips.

- b. Blocking failure is more likely if you block the opponent's attack diagonally from above downward. Block in such a way that the attack is deflected to the side. In the terminal position of the block, avoid allowing the elbow of your blocking arm to deviate in any direction from the recommended position.
- c. Bend the blocking arm 90 degrees at the elbow. Avoid straightening or bending your elbow excessively.
- d. Your block will be ineffective if the wrist of your blocking arm is bent. Straighten and firmly tighten it.

FACTOR 4 - POSITION OF ELBOW OF BLOCKING ARM

25. The instant the block is applied, all power must be concentrated in the forearm. The amount of power you are able to exert depends on the relationship of your elbow to the side of your body. If your elbow is too far removed from your body, it will be difficult to tense the muscles at your side, and your block will be weak. Also, if your elbow remains too close to your body when you block, the scale of your block will be small, and the blocking power reduced. Keep your elbow neither too far away nor too close to your body. Moreover, when blocking body attacks, ensure that your forearm ends its movement in the centre of your body rather than to the left or right. If your elbow and forearm are correctly positioned, the power of hips, body and arm will be concentrated in the forearm. At the moment of impact, fully tense your side and arm muscles.

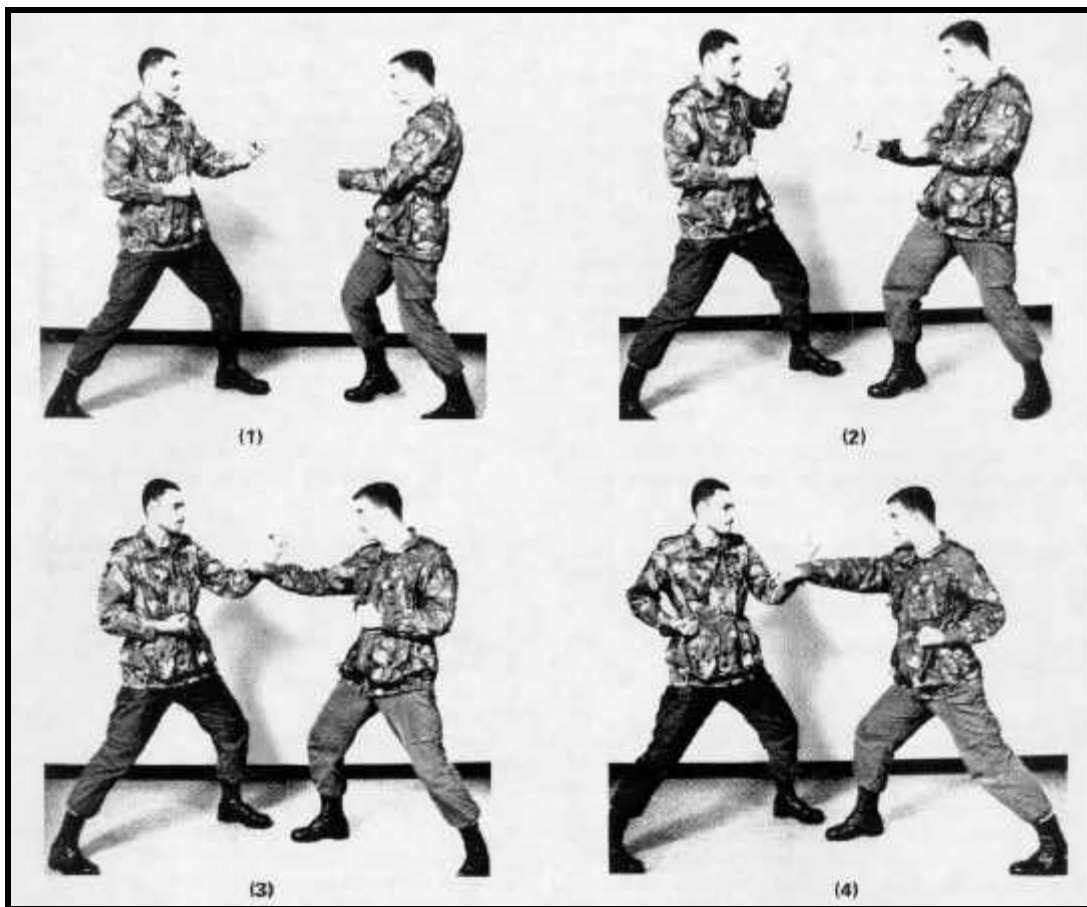

Figure 6-12 Elbow Position

INSIDE MIDDLE BLOCK

26. Block from inside outward with top of wrist. Place the left fist in front of the right hip with the back of the fist in front of the right hip with the back of the fist facing forward. Bring the forearm up and forward, using the elbow as a pivot. Deflect the opponent's body attack by striking his forearm to the side with the top of your wrist from the inside outward. The left hand travels forward outside the right. At the moment of contact be sure your elbow is bent at 90 degrees, your fist is at chin height, and your forearm is almost perpendicular to the ground.

27. Withdraw the right hand to a position above the right hip as your left forearm moves forward to block. Rotate the hips clockwise as you withdraw your right hand. Synchronize the hand and hip movements for additional power. The more power generated by the hips movement, the stronger will be your block.



Figure 6-13 Inside Middle Block

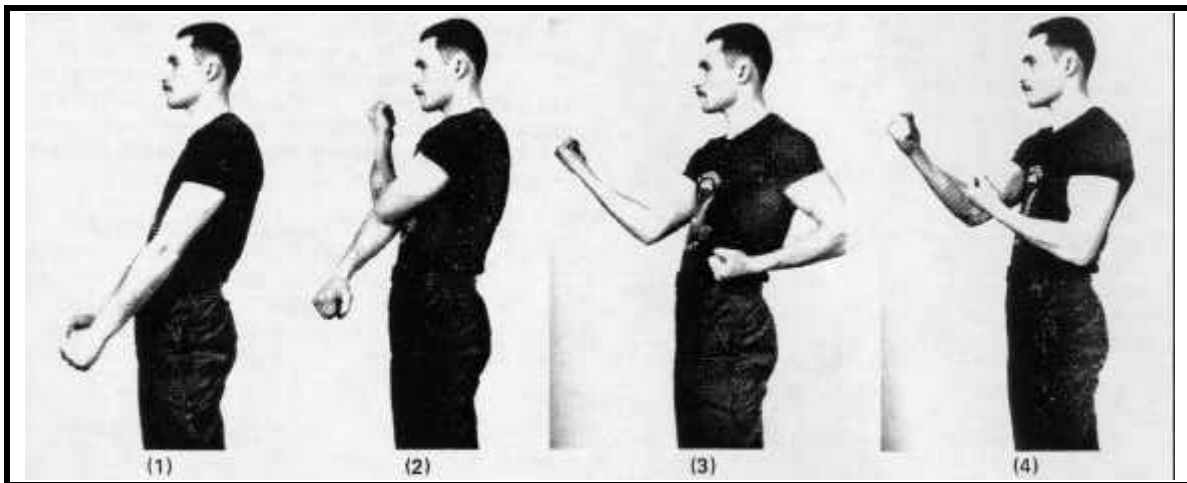

Figure 6-14 Inside Middle Block Sequence (Side View)

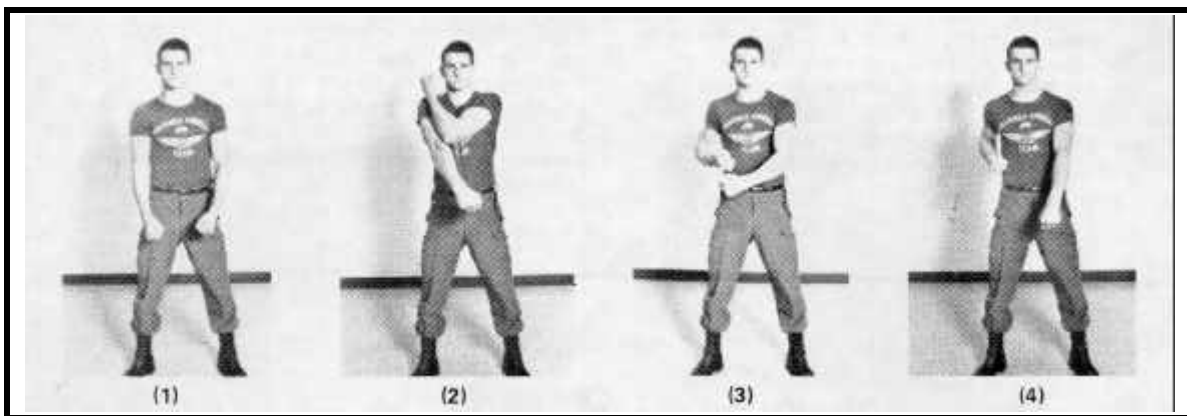

Figure 6-15 Inside Middle Block Sequence (Front View)

TRAINING METHOD FOR MIDDLE INSIDE BLOCK

28. Assume the striking stance of the natural position.
29. Begin a step backward with your left foot. Simultaneously extend your left hand forward, palm down, and place your right fist in front of your left hip with the back of the fist facing up.
30. As your foot continues backward, withdraw your left hand to your left side and rotate your hips counterclockwise. At the same time, swing your right arm forward from the inside outward. Use your elbow as a pivot and rotate your forearm clockwise as you swing it forward.
31. End your block with your body in the right-front stance at fighting stance. The block might just as easily have ended in the straddle-leg stance. The block might just as easily have ended in the straddle-leg stance or the back stance. Whatever the terminal position, the left fist must end above the left hip with the back of the fist facing down.
32. Step forward and return to the striking stance.
33. Repeat the above practice alternately on both sides of the body. Instead of stepping back to render this blocking technique, practice it by stepping forward into the striking stance, or the straddle-leg stance.

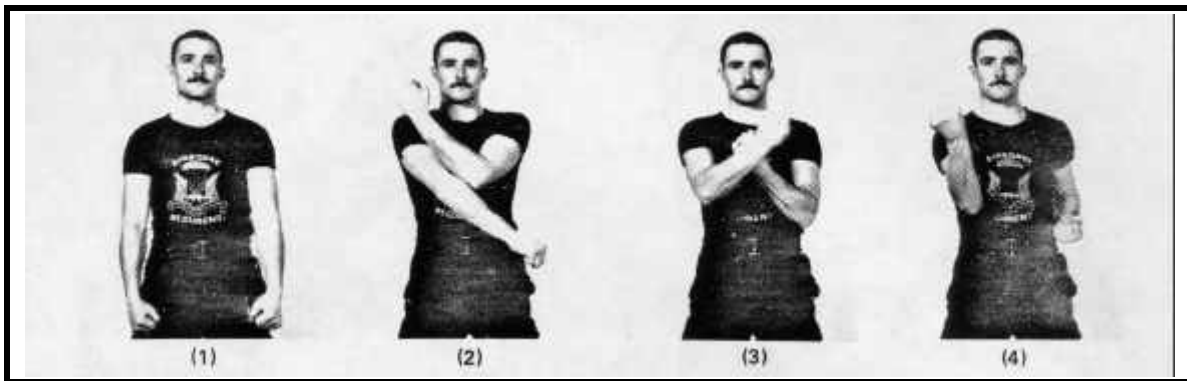

Figure 6-16 Inside Middle Block - Arm Cross

34. **Special Considerations -**
 - a. The inside outward block will be weak if you block with the arm alone. Use the power generated by hip rotation to strengthen your block.
 - b. Avoid blocking with only one arm. Use both arms. In other words, this technique will not exert maximum power unless the non-blocking arm is swiftly and strongly withdrawn.

- c. The position of the elbow of the blocking arm should change very little during the entire blocking movement. Drive the forearm outward as if it were a fan opening. The elbow acts as the pivot of this circular forearm motion.
- d. These blocks are usually practiced as blocks against body attacks, but they are also effective against attacks to the head.

DOWNWARD BLOCK

35. **Direction of Block.** Start the downward block with the left fist beside the right ear. Aim the back of the fist outward to the side. Strike downward, straightening the elbow, and deflect to the side the opponent's attack with the bottom of your wrist. End the downward block with the left fist directly above the left knee.

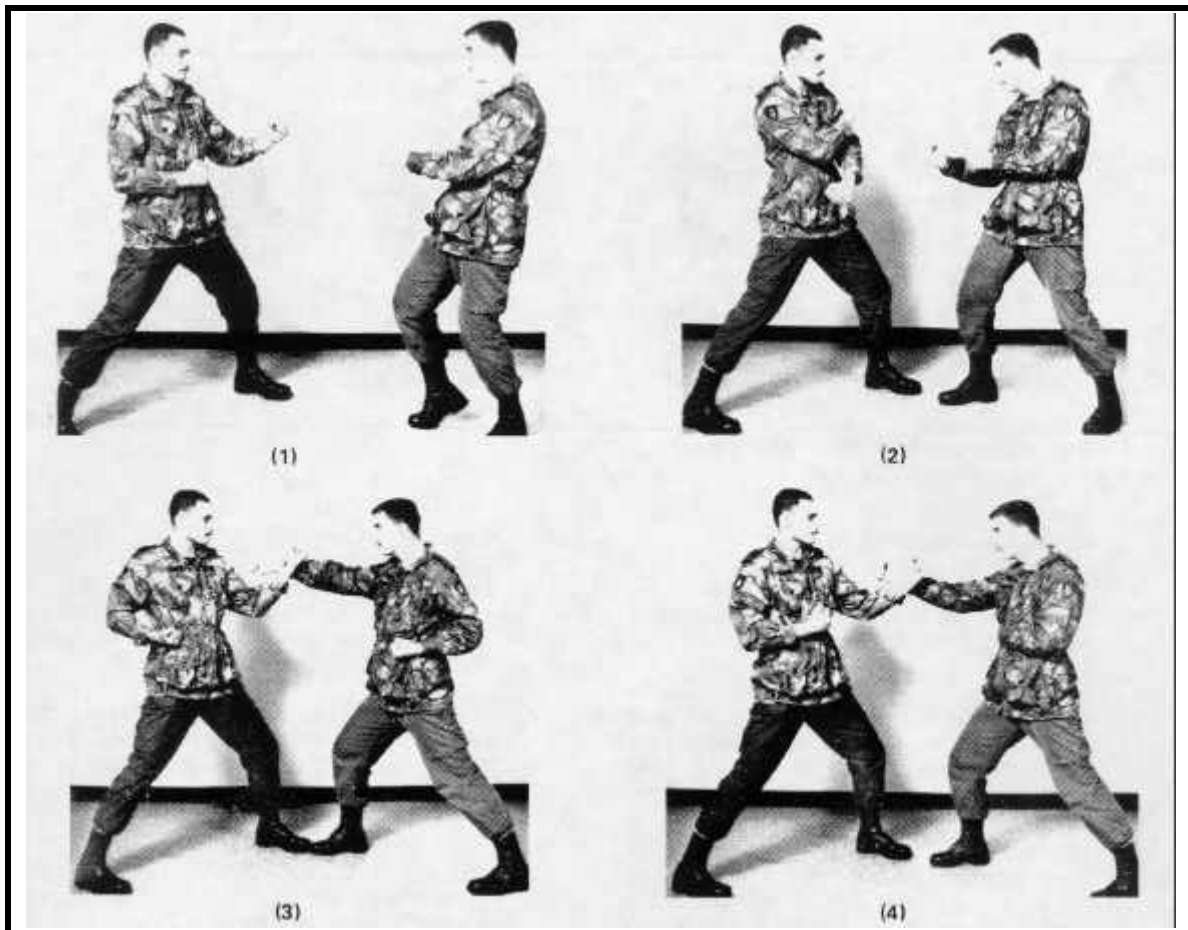

Figure 6-17 Inside Outward Block Sequence

36. **Downward Block Sequence.** Rotate the forearm inward, straighten the elbow, and block with a big downward motion of the arm.

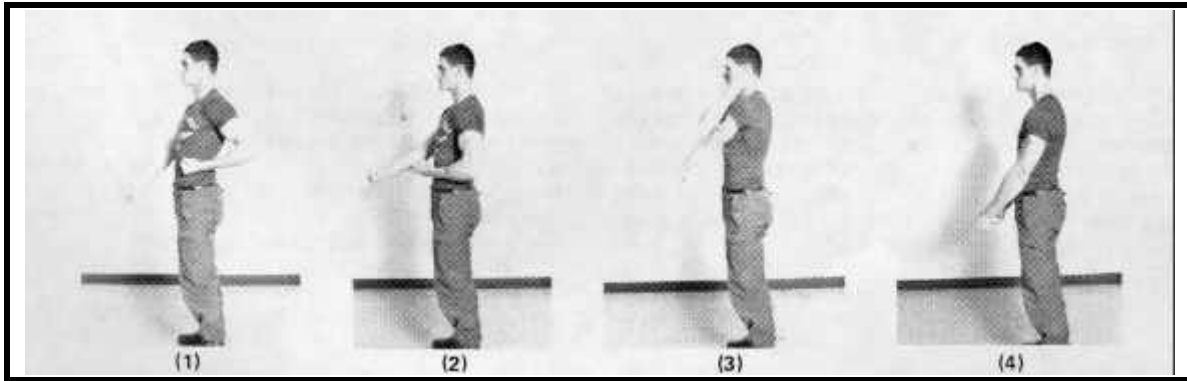

Figure 6-18 Downward Block Sequence

TRAINING METHOD FOR DOWNWARD BLOCK

37. Assume the open-leg stance of the natural position.
38. Begin a backward step with your right foot, your right arm in front of your lower abdomen and place your left fist beside your right ear.
39. Continue stepping backward, withdraw your right hand to your side, forming a fist, and rotate your hips clockwise. Simultaneously, drive your left forearm downward, rotating the forearm and straightening the elbow.
40. End the downward block with your body in the left-front stance at fighting stance. Your right fist should be above your right hip with its back facing down. Your left arm should end above your forward leg with the back of the fist facing up.
41. **Special Considerations -**
 - a. If you are afraid of the opponent's attack, you are apt to withdraw your hips to avoid being hit. This action weakens the downward block. It is difficult to block a powerful kick if your body leans forward. Push your hips forward during the block to maintain your body perpendicular to the ground.
 - b. If you attempt a downward block without fully rotating your hips, your block may prove ineffective. Because the opponent's kick to your groin is very powerful, place special emphasis on hip rotation to generate the strength necessary.
 - c. If your hips are too high as you block, the opponent's chances of delivering a successful attack increase. Keep your hips low and block from a position as close as possible to the opponent.

42. If the fist of your blocking arm deviates from the recommended six inches above the forward knee, your block may fail. If your block ends too far above your knee, the opponent's kick will hit your abdomen. If it ends too close to your knee, your block will miss the kick completely and your chin will suffer the consequences (see Figure 6-19).

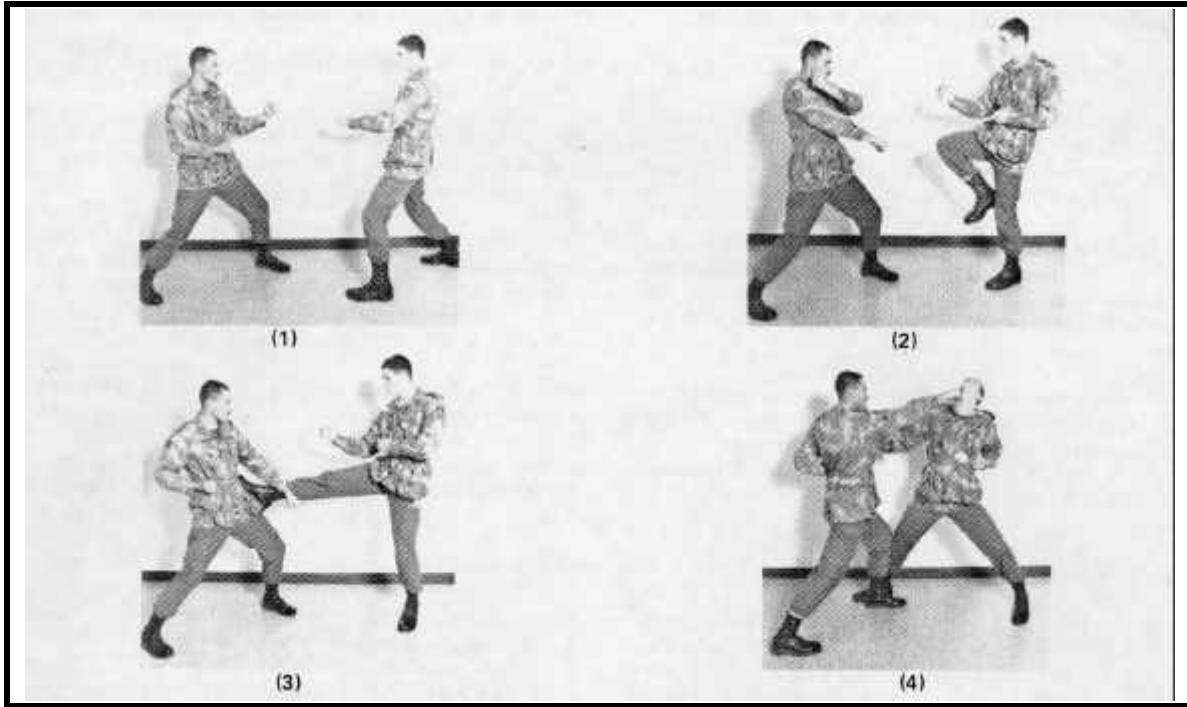

Figure 6-19 Downward Block Application

CONCLUSION ON BLOCKING

43. Concentrate on mastering the blocks designed to parry the various attacks. Remember that your block will be stronger if it travels a longer route to its destination. Although this longer route is desirable, it is usually not possible because there is only limited time in which to block. Because they must respond to attacks of great speed and suddenness, advanced students inevitably do not begin their blocks from the positions outlined above. However, beginners must master the block in its full and correct course before they can expect to use a shortened version of it. In every case, beginners must concentrate on learning the basic techniques.

CHAPTER 7

ELBOW AND KNEE STRIKES

ELBOW STRIKES - GENERAL

1. The elbow strike differs somewhat from strikes utilizing the hand. It belongs to the category of smashing techniques rather than to striking techniques. The elbow strike is performed by driving the elbow forward, sideward, backward, upward, or downward. The elbow strike is most effective in situations where the free movement of the body is lost. For example, it serves as an effective defensive technique when an opponent holds your wrist or your arm.



Figure 7-1 Elbow Strike

IMPORTANT CONSIDERATIONS

2. The elbow strike is effective when used to counterattack at short range, but tends to lose its value as the distance from the opponent increases.
3. When applying the elbow strike, keep the upper body perpendicular to the ground. Move the hip in the direction of the strike. If the upper body is not kept perpendicular to the ground, the technique will be weak.

4. Keep the fist and forearm of the striking arm as close to the body as possible, brushing the side of the body at the start of the technique.
5. Rotate the forearm anywhere from 90 to 180 degrees to gain greater striking power. Place the forearm initially in such a position that this rotation is possible.
6. Relax the shoulders. To increase the impact, bend the elbow fully and tense the arm muscles just before striking the target.
7. Use a forward elbow strike to attack the opponent's chest or abdomen when he is directly ahead. This strike is especially effective when standing face to face with an opponent who has grasped your wrist or jacket.

ELBOW STRIKE TRAINING METHOD

8. Assume the left-front fighting stance.
9. Place the left hand in front of the body, and the right fist above the right hip with the back of the fist facing downward.
10. In one coordinated action, withdraw the left fist to a position above the left hip, thrust the right hip forward, and drive the right elbow in a half circle toward the target. Rotate the right forearm 180 degrees counterclockwise as you drive the elbow forward.
11. At the conclusion of this movement, the upper body faces forward and the top surface of the forearm is up. Be sure to twist the forearm inward as much as possible.
12. Return to the position in # 1 in Figure 7-2, withdrawing the right hip. This movement can be practiced from right, as well. as left-front stance. It is also necessary to practice the forward elbow strike when shifting from natural position to front stance.

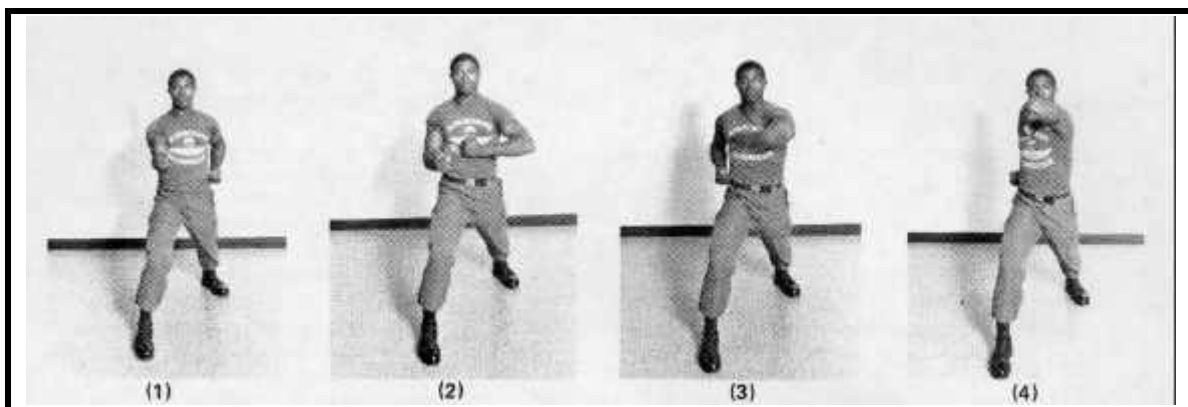

Figure 7-2 Elbow Strike Training Method (Front View)

13. **Important Considerations -**

- a. Keep the right fist close to the body as you apply the forward elbow strike. Its correct path is from the right hip to the left side of the chest. Brush the right forearm along the side of the body as you bring the elbow forward.
- b. Use the upward elbow strike to attack the chin or solar plexus of an opponent directly ahead. This elbow strike is extremely effective when delivered from a low position attained by moving into and under the opponent's attacking arm.

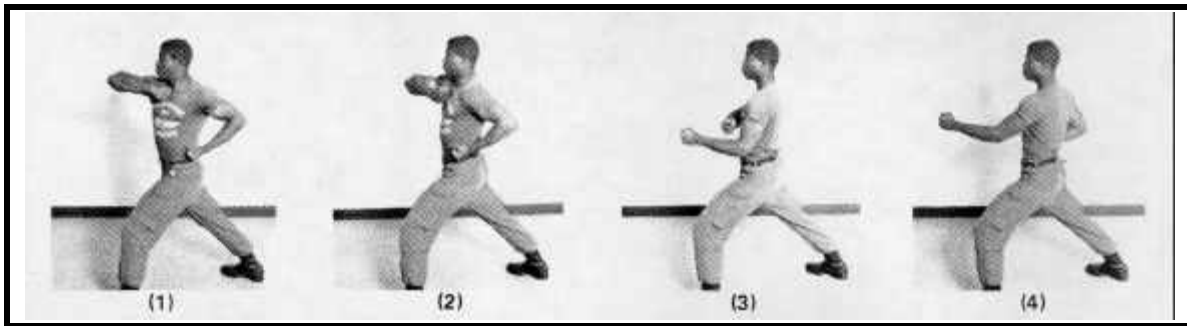

Figure 7-3 Elbow Strike Training Method (Side View)

TRAINING METHOD FOR UPWARD ELBOW STRIKE

14. Assume the right-front striking stance with the body facing forward.
15. Extend the open left hand in front of the body at about the height of the solar plexus with the back of the hand facing up. Place the right fist above the right hip with the back of the fist facing down.
16. Withdraw the left hand to a position above the left hip, rotate the hips counterclockwise, and bring the right elbow forward and upward in a half circle.
17. Simultaneously, complete the withdrawal of the left fist, turn the upper body to the left at a 45 degrees angle to the front, and finish the strong upward thrust of the right elbow. End the movement of the right fist beside the right ear.
18. Rotate the hips clockwise and return to the original position. Practice this movement alternately on both sides. Also, practice the upward elbow strike by moving from the natural position to the striking stance.

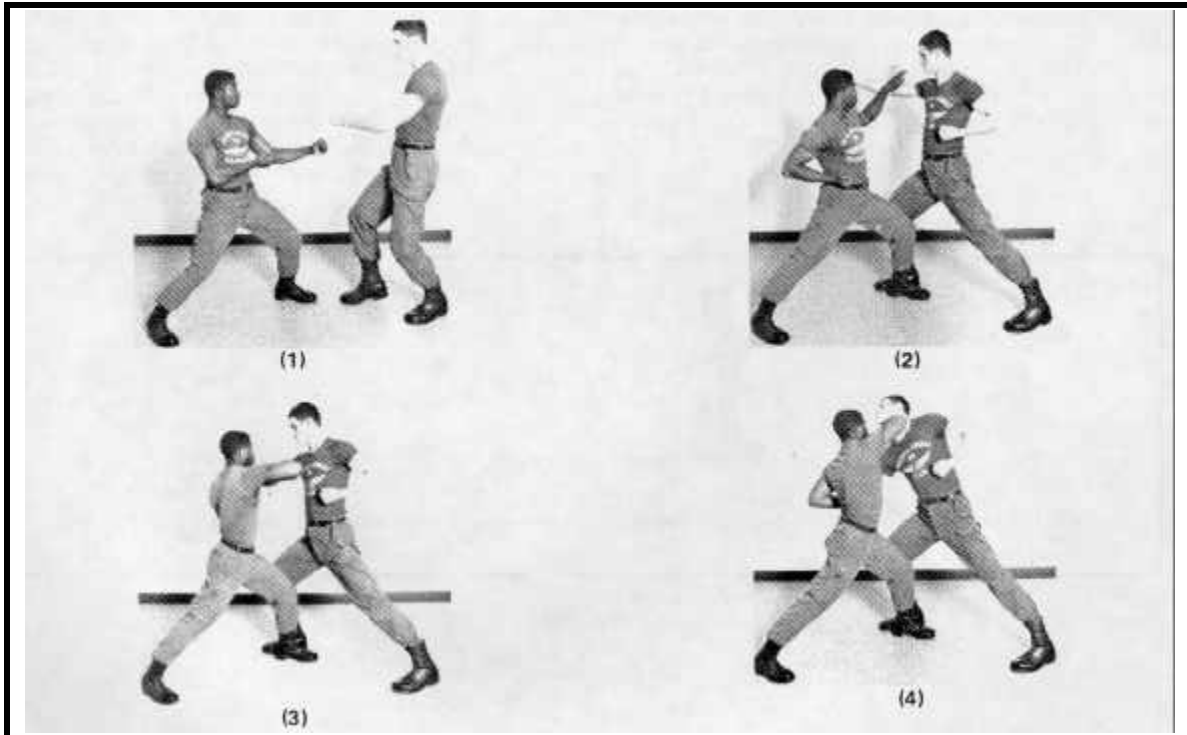

Figure 7-4 Upward Elbow Strike Sequence

19. **Important Considerations -**

- a. Keep the forearm close to the side as it travels upward. Coordinate the upward movement with the rotation of the hips.
- b. Rotate the hips along a plane parallel to the ground so that the upper body remains perpendicular to the ground.
- c. Tighten the buttocks as if to push them upward. Do this in addition to rotating the hips and the strike will be more powerful.

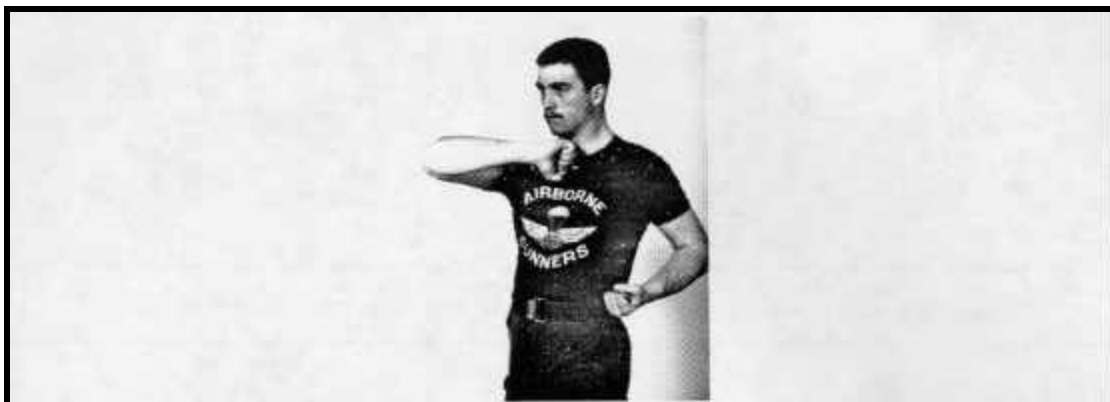

Figure 7-5 Upward Elbow Strike

STRIKING TECHNIQUES WITH THE KNEE

20. The knee is another striking technique which falls in the category of smashes. The knee techniques are performed upward and sideward. It is most effective in situations where free movement of the body is lost. The object of the knee lift is to force the knee, from the standing position, into the face or groin of the opponent.

21. Important Considerations -

- a. The knee smash is effective only when used in very close quarters. It tends to lose its value at a distance.
- b. This technique is relatively slow and its true effect is in smashing a relatively immovable target. Therefore, this technique must be executed in conjunction with a technique to immobilize the target or a technique where the target is forced towards the knee.

Example 1 - Pull your opponent's head down while you drive the knee upward.

Example 2 - Force down on your opponent while you drive your knee up between his legs (see Figures 7-6 to 7-9).



Figure 7-6 Knee to Head - Start Position



Figure 7-7 Knee to Head

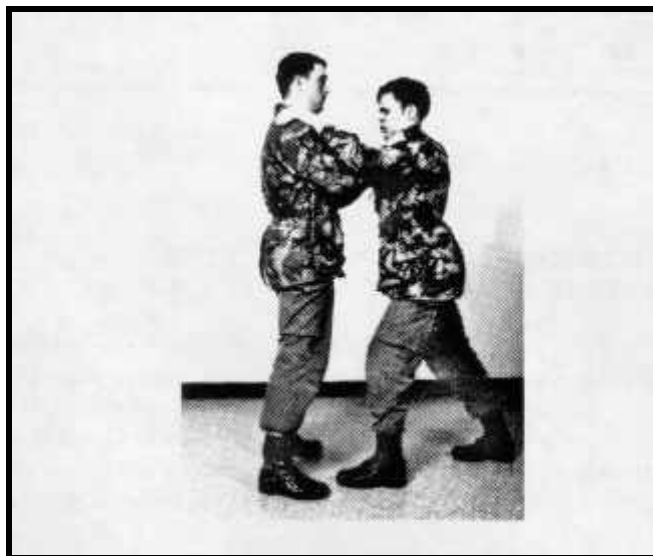

Figure 7-8 Knee to Groin - Start Position



Figure 7-9 Knee to Groin

CHAPTER 8

BASIC MOVEMENT

STANCE TRAINING IN CONTINUOUS MOVEMENT

1. In general, when moving, keep the hips at the same level and slide the feet lightly across the floor. To practice moving, first take five steps forward and then turn and take five steps in the opposite direction. Of course, it is also possible to retreat instead of turning, affording practice in moving away from an attack.

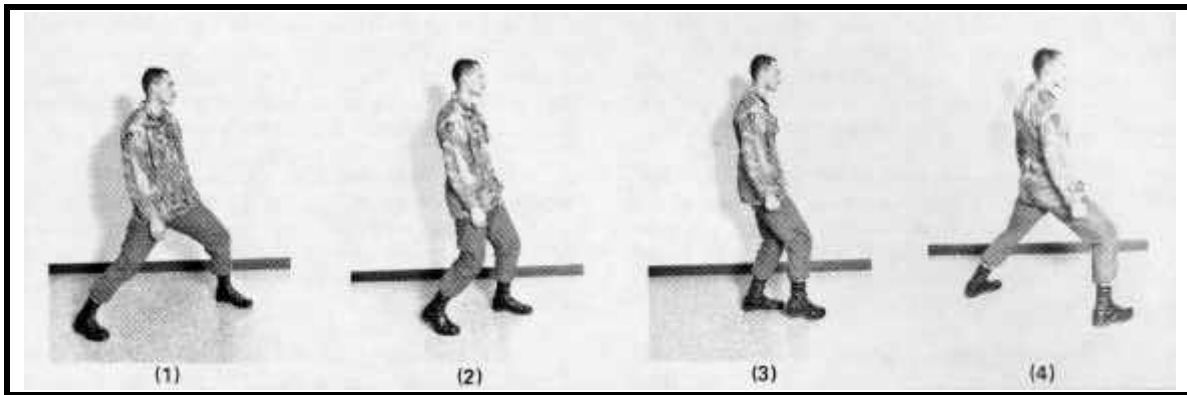

Figure 8-1 Front Stance - Advancing and Retreating

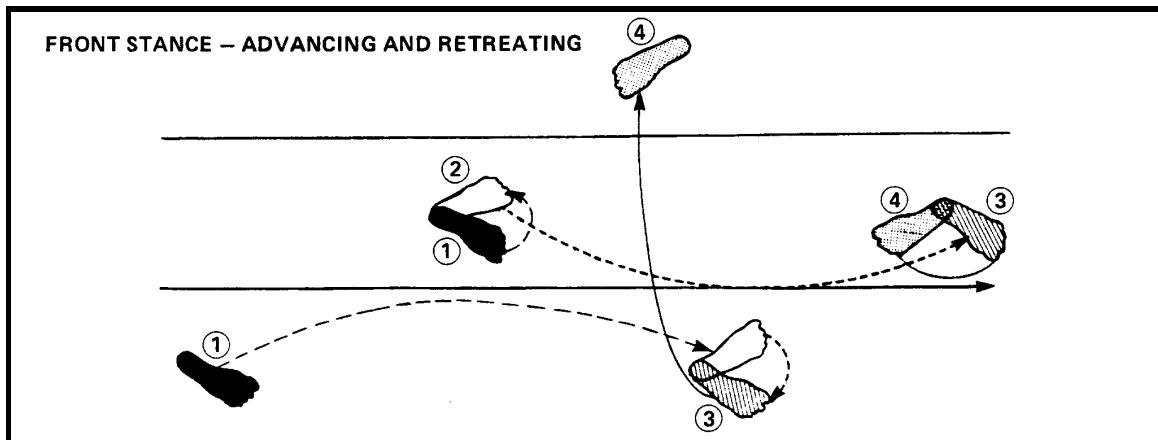

Figure 8-2 Front Stance - Advancing and Retreating (Foot Movement)

MOVING FROM THE LEFT-FRONT STANCE TO THE RIGHT-FRONT STANCE

2. Begin by shifting the weight to the supporting leg and moving the centre of gravity forward. Keep the knee of the supporting leg bent, but flexible. Tighten the muscles of the supporting leg.
3. Draw the rear leg to the supporting leg as the body moves forward. Relax the muscles of the rear leg to facilitate a smooth forward movement.
4. Keep the foot of the supporting leg in firm contact with the floor. Lift the opposite foot slightly and draw it forward to a position next to the foot of the supporting leg. The feet should touch slightly.
5. Halfway through the forward movement thrust sharply backward and downward with the supporting leg at an angle of 45 degrees to the ground. This will drive the hips forward. At the same time, advance the opposite foot one step. Keep the upper body perpendicular to the ground throughout this movement.
6. Relax the moving leg during the forward movement, but at the instant of termination tense all the muscles involved. After an instant's tension, the muscles relax again and the moving leg becomes the supporting leg for the next forward movement, or plays its role in some other action.
7. When stepping forward, the moving leg must swing in a half circle to the supporting foot and then out again. Move the foot smoothly and maintain continuous movement. Imagine that the thickness of a sheet of paper separates the foot from the ground.
8. Be sure that the hips move along a plane parallel to the ground, with no fluctuation up or down. Also, prevent the hips from swaying from side to side during the movement. Any deviation from the horizontal plane will reduce the force of the forward thrust.
9. Flex the muscles of the lower abdomen throughout the movement, and keep the upper body perpendicular to the ground. The latter point is important to retain the ability to adjust to changing circumstances.

THINGS TO AVOID

10. The thrust of the rear leg is weak and the body is pulled forward with the shoulders (see figures). This impairs stability and results in ineffective techniques. Tighten the ankle of the rear leg and drive it strongly backward and downward.

11. The heel of the rear foot is raised and the front foot bears too much weight during the forward movement. If the opponent sweeps your front foot with the foot sweep, you will fall. Keep the heel of the thrusting foot pressed firmly against the ground.

12. The foot of the moving leg steps forward in advance of the movement of the upper body. This prevents a coordinated movement of the body and contributes to an ineffective technique. Advance the hips as quickly as possible and attempt to coordinate the body's action. All parts of the body must come to a stop at the same instant. Note that if the front steps out in advance of the rest of the body, the opponent can easily apply a foot sweep, as in point 2 above.

TRAINING METHOD - THRUSTING HIPS FORWARD

13. Assume the left-front striking stance with the hands on the hips.

14. With the left leg supporting the weight, draw the hips and the right foot forward, keeping the upper body perpendicular to the ground.

15. At the halfway point of the forward movement, the left foot supports the weight, the right foot is next to the left and parallel to it, lightly touching the ground. The right hip and shoulders are still slightly to the rear (see figure).

16. Pressing the hips forward, thrust sharply backward and downward with the left leg and step forward with the right. Assume the right-front stance, facing forward.

17. Return the right foot to its original position and assume the left-front stance.

18. Repeat this action several times and then practice on the opposite side. After additional training in these movements, go continuously forward from the left-front stance to the right-front stance to the left-front stance, without returning to the original position as before.



Figure 8-3 Thrusting Hips Forward

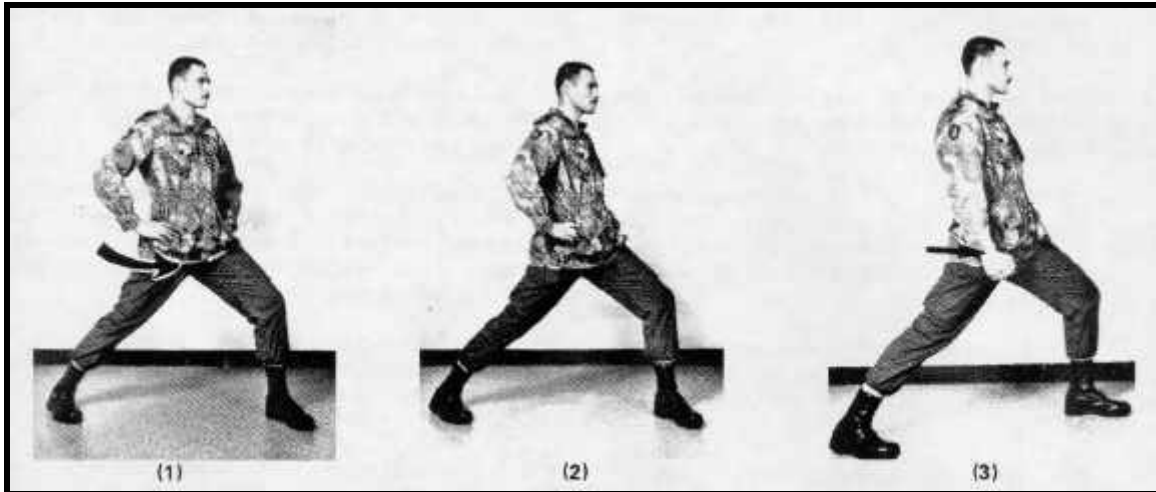

Figure 8-4 Training Method for Thrusting Hips Forward

THINGS TO AVOID

19. The supporting leg is not stable and the body is unsteady as it moves forward. If this occurs, the hips cannot be pushed forward strongly. Tighten the ankle and the knee of the supporting leg. However, retain some flexibility in the knee of the supporting leg.
20. The moving leg advances erratically. Relax the muscles of the moving leg to permit a light smooth forward movement.
21. When the hips advance, the upper body leans forward and does not remain perpendicular to the ground. Press the hips strongly forward with the thumbs.

CHAPTER 9

HOLDS AND COUNTERS

GENERAL

1. The three main purposes of a hold are:
 - a. to subdue your opponent until you can secure him for safekeeping;
 - b. to injure your opponent and place him in a position to receive your follow-up blows to the more vulnerable parts of his body in order to overcome his resistance and eliminate him as a threat; and
 - c. to kill your opponent immediately by applying enough pressure to certain parts of his body.

2. Properly executed, any strangle hold can cause unconsciousness in approximately 2 or 3 minutes. Continued pressure will kill a man in less than 4 minutes. Caution must be used in training: holds are applied with some pressure to assure understanding of the power involved, yet not enough pressure to cause injury.



Figure 9-1 Strangle Hold

REAR STRANGLE HOLD

3. The object is to encircle your opponent's head and apply pressure to his throat with your arm and strangle him. Then, by simply dropping to the ground, the neck can be broken. This attack is particularly good because it can be applied quickly, and the victim cannot yell out for help.

4. **Training Method.** Stand directly behind your opponent. Place both arms over his shoulders and grab your right bicep with your left hand, ensuring the bony part of the wrist of the left hand is forced into the opponent's Adam's apple. Then simply pull the left elbow to the rear.

5. **Important Considerations -**

- a. If the opponent's neck is allowed to slip into the crux of your elbow, the technique loses its immediate effect, although you can still strangle your opponent.
- b. This technique must be applied vigorously while directing your opponent's weight backwards to keep him off balance.
- c. Once the victim is off balance, he cannot defend against this technique. To break his neck, simply drop straight to the ground while maintaining your hold.

REAR STRANGLE HOLD (AMERICAN)

6. Much like the Japanese rear strangle hold this technique encircles the opponents neck for the purpose of strangling him.

7. **Training Method.** Stand directly behind your opponent. Place one wrist at the adam's apple and grasp the hands together tightly. Force the bony part of the wrist into the opponent's throat. Ensure your head is very close to the opponent's head to ensure control.



Figure 9-2 Rear Strangle Hold (American)

CLAW

8. The object of this technique is to collapse the wind pipe. Fingers must circle the wind pipe and squeeze as hard as possible.



Figure 9-3 Claw

BENT WRIST LOCK

9. The object of this hold is to bend the opponent's wrist in such a manner as to cause severe pain or if desired, to break his wrist. This technique is used when you are required to persuade your opponent to come along.

10. **Training Method.** Stand directly in front of your opponent and grasp his left hand by placing your left hand palm down on top of his. Ensure your thumb applies pressure to the middle of his thumb. Simply apply pressure and rotate anti-clockwise, forcing your opponent to turn to his right.

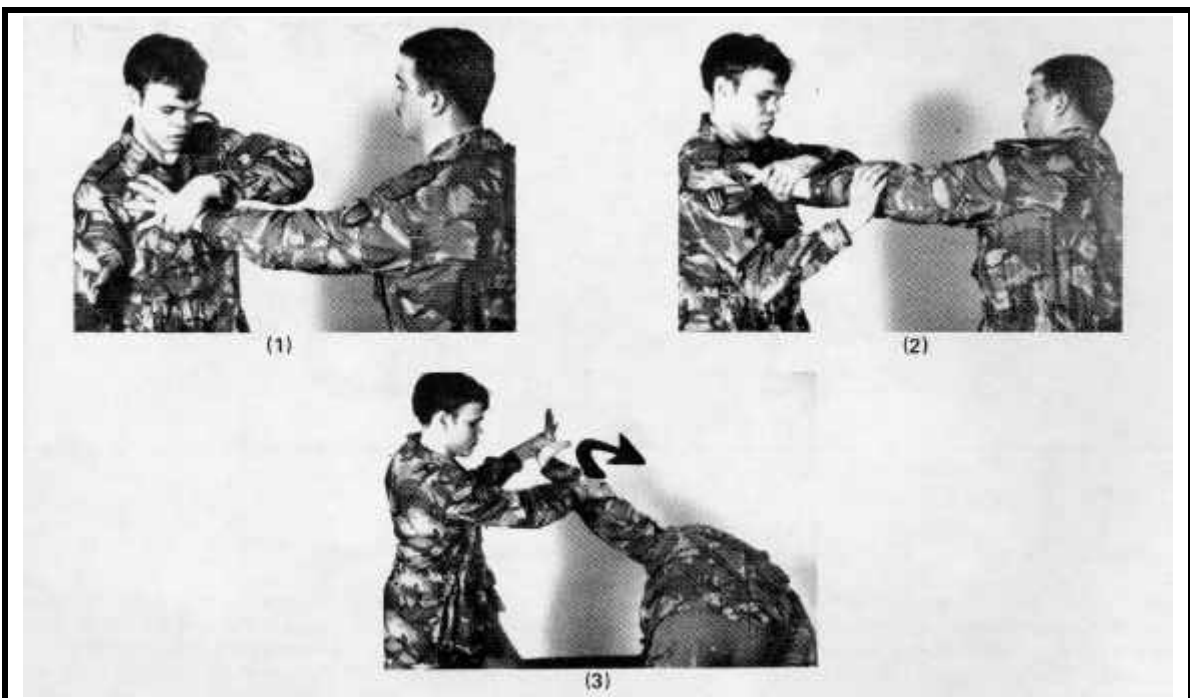

Figure 9-4 Bent Wrist Lock

11. **Important Considerations -**

- a. The entire technique relies on pressure to the opponent's thumb.
- b. You may wish to use both hands against a stronger opponent. Once the hold is in place, pressure can then be applied to the elbow to ensure the arm remains locked.

ARM BOW

12. **Objective.** The objective is to bring someone along or to break his arm. It is used when handling prisoners.

13. **Training Method.** Grasp one of the opponent's arms with your outside hand. Force his head back with a hammer fist smash to ensure minimum resistance. Slide that same arm under the elbow and apply pressure upward on the opponent's elbow joint.

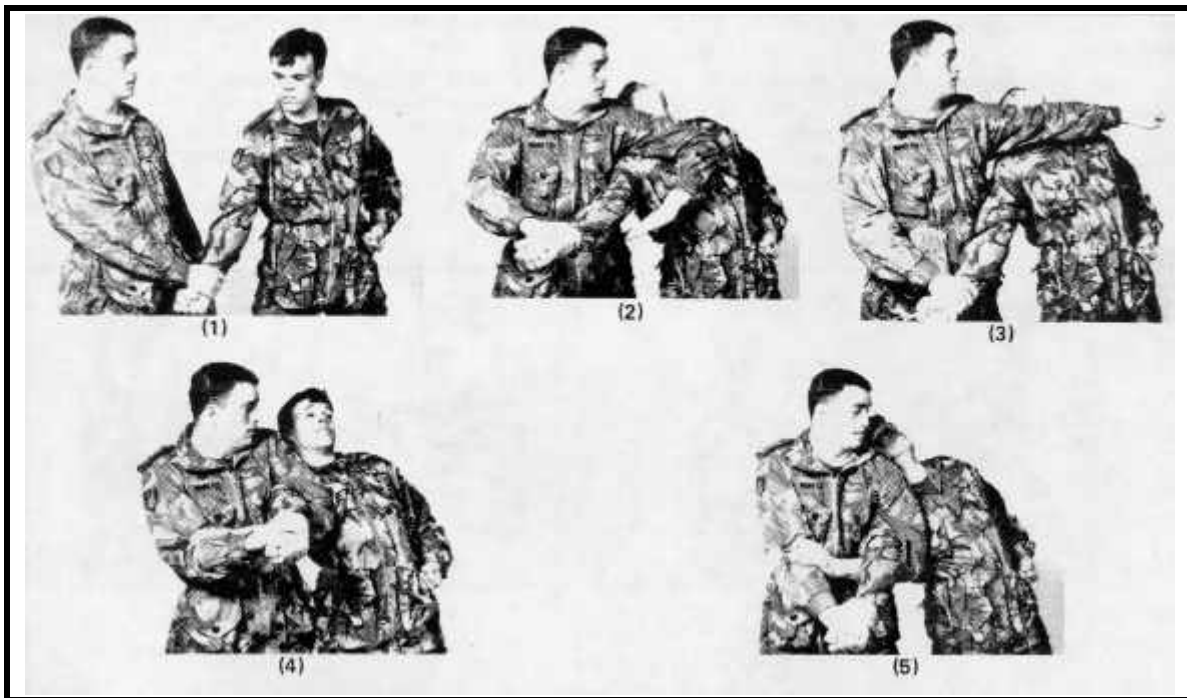

Figure 9-5 Arm Bow Sequence

SUMMARY ON HOLDS

14. There are numerous other holds and variations to the ones mentioned here. It is important to remember that many holds taught today can be more of a hindrance than a help. Ensure that the holds you master are relatively escape-proof, or at best, leave you in an advantageous position to strike if a hold is broken.

HOLD COUNTER-MOVES - GENERAL

15. If your opponent succeeds in getting a hold on you, you must break the hold before or immediately after he completes it. Bite, kick, or hit him at vulnerable points to help loosen or break the hold before he can apply pressure. By escaping from your opponent's grasp immediately, you can take the offense and attack him.

COUNTERS TO A CHOKE HOLD

16. **Objective and Use.** Your objective in countering a choke is to act quickly to break the hold. Use of this counter works best if your opponent's arms are extended.

17. **Description -**

- a. When your opponent attempts to choke you, use a roundhouse arm swing or break his hold;
- b. As you swing your arm over his arms, pivot in the direction of your swing to get as much as your body weight as possible behind your arm swing. This causes your opponent to loosen his hold; and
- c. This escape also can be used against a choke hold from the rear. Swing your arm and pivot around, facing your opponent as your swing.

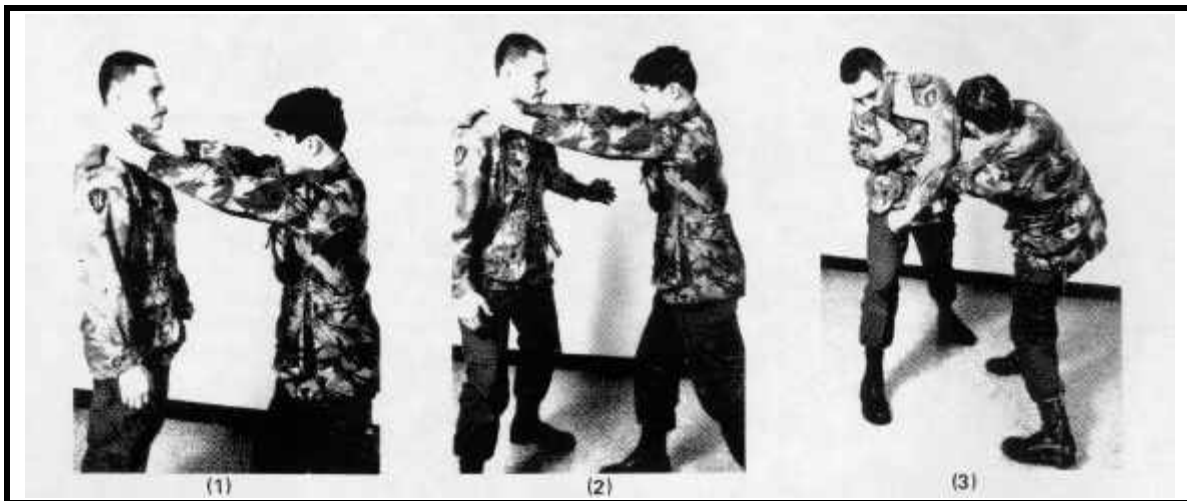

Figure 9-6 Choke Hold Counters

COUNTER TO REAR STRANGLE HOLD

18. **Objective and Use.** The objective of this counter is to break the strangle hold to permit resumption of your attack. This counter is used when the enemy applies a strangle hold from the rear, encircling his arm around your neck.

19. **Description.** If your opponent attempts to apply a rear strangle hold, immediately grasp his arm with your opposite hand and bend deeply at the knees, twisting your body in the opposite direction of your free arm. Vigorously rotate your upper body and drive your free elbow into his armpit. You always will deliver this blow towards the arm encircling your neck.

20. **Follow-up or Recovery.** The elbow smash to the ribs or armpit will cause your opponent to lose his grip and provide the time needed to quickly turn and deliver an effective kick or stomp.



Figure 9-7 Strangle Hold Counter

COUNTER TO A HEAD LOCK

21. To counter a simple headlock do one or all of the following techniques. See Figures 9-8 through 9-11.



Figure 9-8 Twist



Figure 9-9 Bite



Figure 9-10 Grab



Figure 9-11 Gouge

COUNTER TO A BEAR HUG

22. To counter a bear hug, do one of the following techniques. See Figures 9-1 2 through 9-1 4.

CONCLUSION ON COUNTERS

23. There are numerous other counters and variations to the ones mentioned here. It is important to remember that you must be violent in your attempt to break free. Once free, you must then attack before he regains his balance.



Figure 9-12 Bear Hug Counter - Stomp



Figure 9-13 Bear Hug Counter - Smash



Figure 9-14 Bear Hug Counter - Grab

CHAPTER 10

KNIFE FIGHTING/DEFENCE

GENERAL

1. A knife (or bayonet), properly employed, is a deadly weapon. You can use it on patrols to silence an enemy sentry or you can use it for close-in fighting when you do not have a rifle.



Figure 10-1 Knives

GRIP

2. The proper knife grip is essential for maximum control. To form a proper grip, begin by laying the knife diagonally across the outstretched palm of your hand.

3. Grasp the small part of the handle next to the cross guard with your thumb and forefinger. Your middle finger encircles the handle at its largest point. Do not hold the knife too tightly.

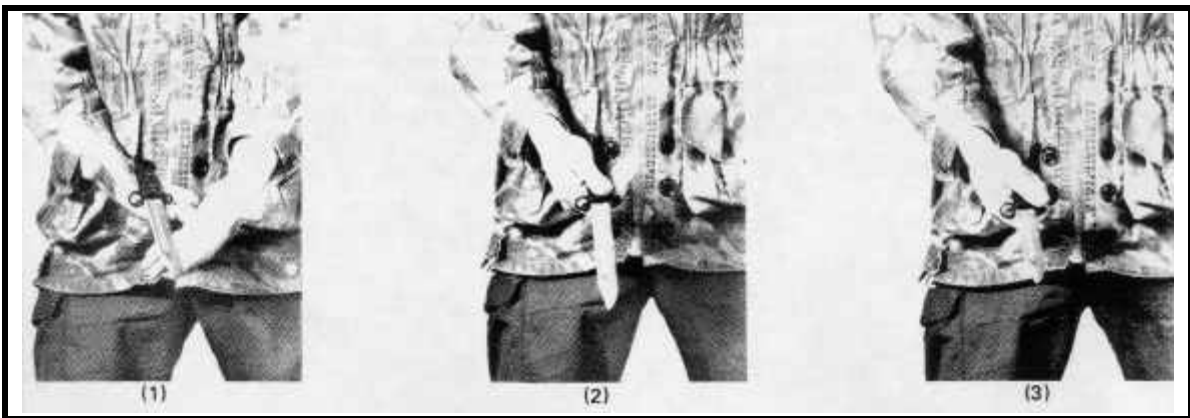

Figure 10-2 Knife Grip

4. When the knife is held in this manner, it can be manoeuvred in all directions. You can control the direction of the blade by a combination movement of the forefinger and middle finger and turning of the wrist. When the palm is turned up and you are holding the knife in your right hand, you can slash to the right or left. When the palm is turned down, you also can slash in either direction. You can thrust when the palm is held either up or down. Just before the knife makes contact, you hold it tightly with all fingers.

STANCE

5. When engaging in a knife attack, your stance should be high to ensure speed. The knife can be hidden or in the open. It is suggested that the knife not be held by the forward hand in the fighting unless your opponent also has a knife.

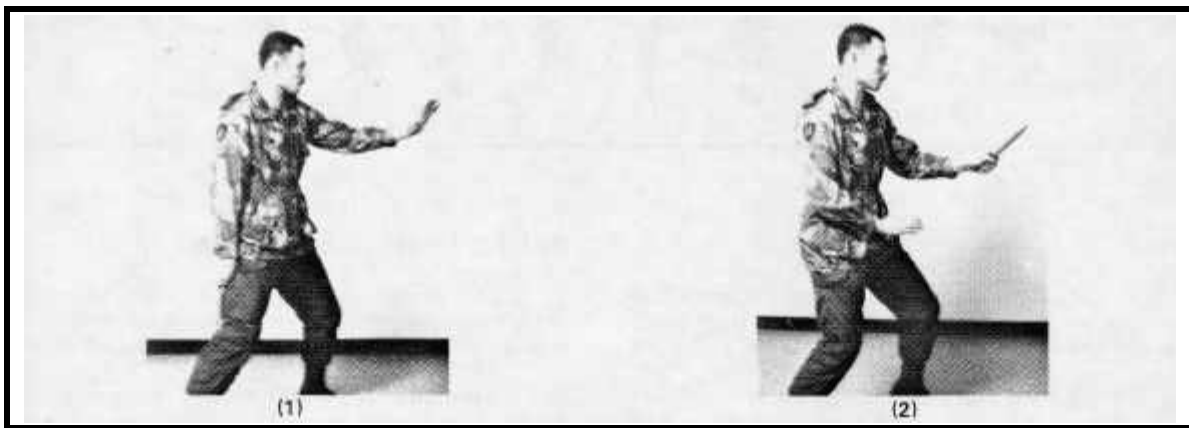

Figure 10-3 Stance

6. **Objective.** The objective of using a knife is to kill your opponent. To do this stab your opponent in the chest and abdomen area. In order to create an opening you may well be required to slash.

STAB MOVING FORWARD

7. See Figure 10-4.

STAB LUNGING FORWARD

8. See Figure 10-5.

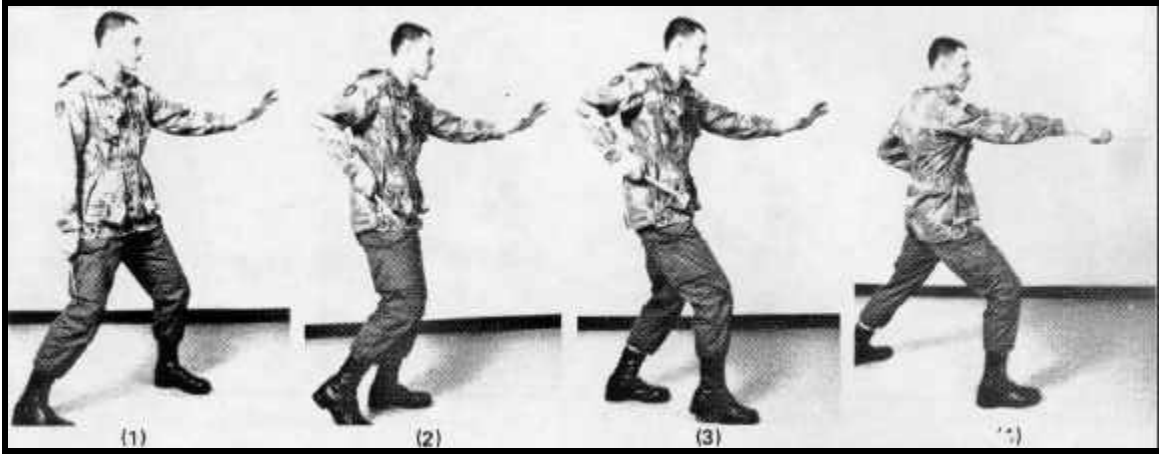

Figure 10-4 Stab Moving Forward

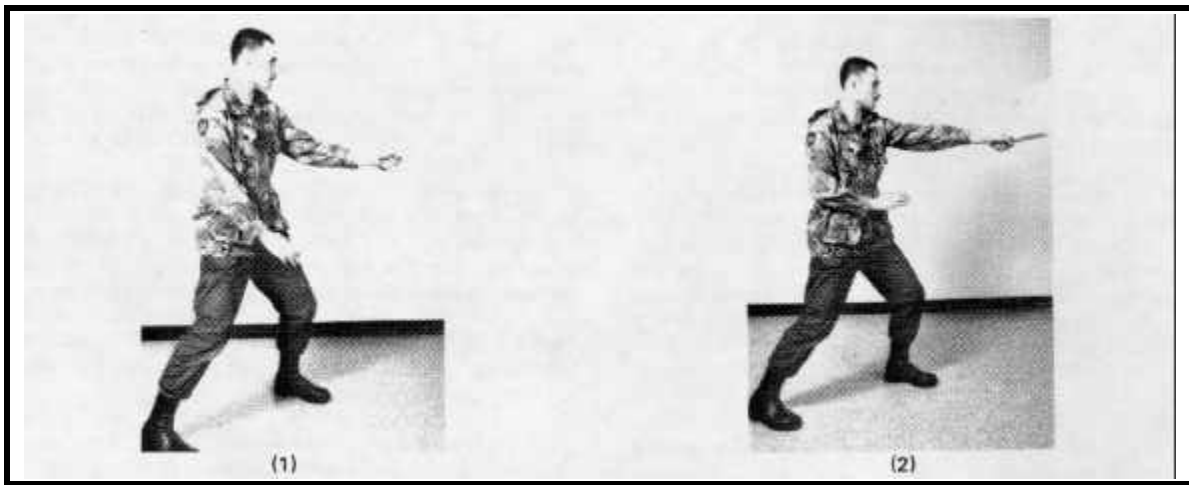

Figure 10-5 Stab

LASHING

9. Lashing is a fast movement who intends to chop. One may take care of not extending the arm to much.

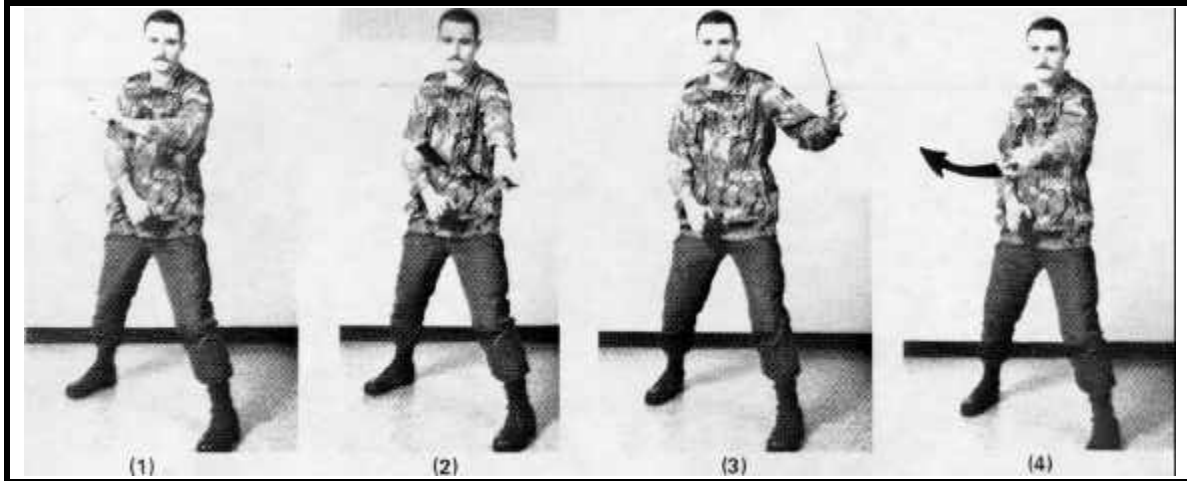

Figure 10-6 Lashing

FRONT ATTACK

10. When you attack an opponent from the front with a knife, he instinctively tries to protect his stomach and throat. If he is wounded in one of the places his fear may be so great that he forgets to defend himself and you can kill him.

11. **The Throat.** You can attack the throat with either a thrust or a slash. The thrust is most effective if the knife is driven into the base of the throat just below the adam's apple. This type of blow cuts the jugular vein and results in almost instant death. A slash to either side of the neck cuts the carotid artery which carries blood to the brain. Your opponent will die within a few seconds from loss of blood.

12. **The Stomach.** A thrust combined with a slash to the stomach produces great shock. Your opponent will be stunned and unable to defend himself. You can then deliver a killing blow. A deep wound in the stomach causes death if the wound is unattended.

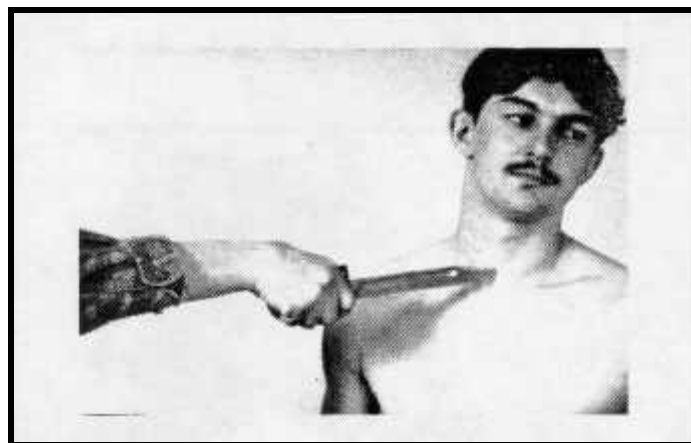

Figure 10-7 The Throat



Figure 10-8 Stomach

13. **The Heart.** A thrust into the heart causes almost instant death. The spot is difficult to hit because of the protecting ribs. A hard thrust, however, usually will slip off the rib and penetrate the heart.

14. **The Wrist.** A slash to the wrist will sever the radial artery, causing death within 2 minutes. This type of attack is excellent if your opponent attempts to grab your clothing or arm. The radial artery is one-quarter inch below the surface of the skin. Unconsciousness results in about 30 seconds.

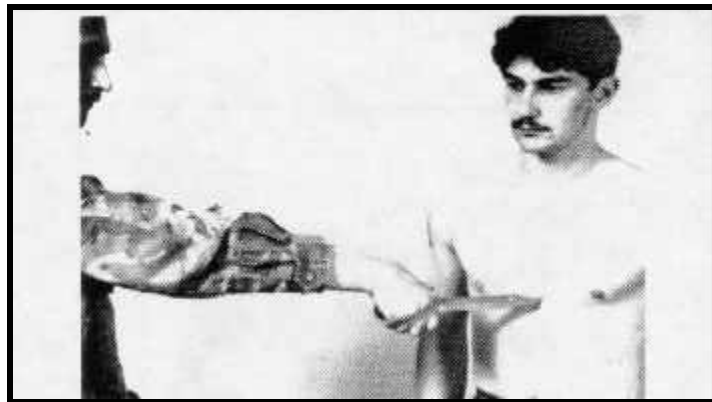

Figure 10-9 Heart

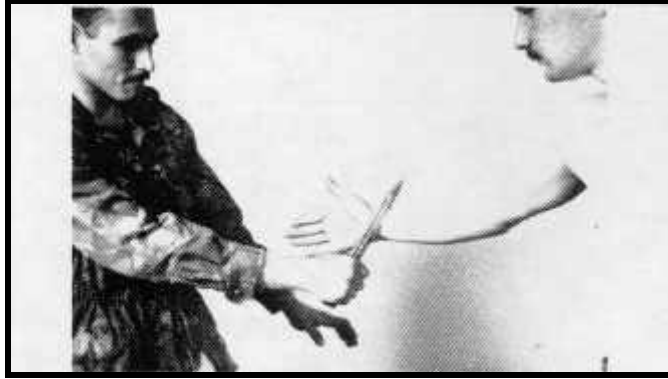

Figure 10-10 Wrist

15. **The Upper Arm.** A slash to the upper arm just above the inside of the elbow cuts the brachial artery and causes death within 2 minutes. This artery is about one-half inch below the skin surface. Unconsciousness occurs in about 15 seconds.

16. **The Leg.** A slash to the inside of the leg near the groin severs the arteries there and makes the leg useless.



Figure 10-11 Upper Arm

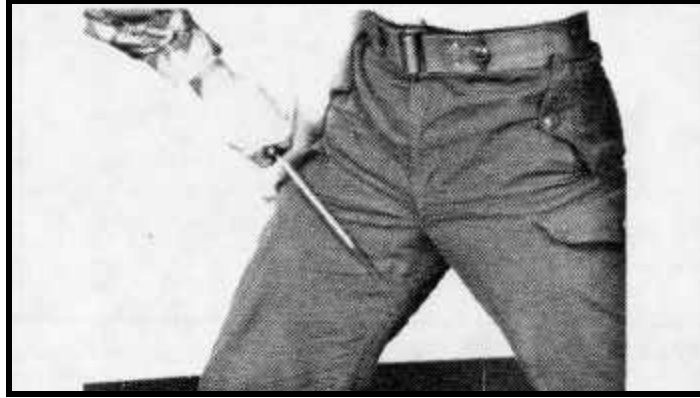

Figure 10-12 The Leg

ATTACK FROM THE REAR

17. When attacking an opponent from the rear, you should launch your attack immediately upon reaching a position not less than five feet from him.
18. **The Kidney.** Thrust the knife into your opponent's kidney and simultaneously grab his mouth and nose with your other hand. After a short interval, withdraw the blade, slashing as you do so, and then cut his throat. The thrust to the kidney produces great shock and causes internal hemorrhage and death.
19. **Side of the Neck.** A thrust into the side of the neck is effective when you want to maintain silence.



Figure 10-13 The Kidney



Figure 10-14 Side of the Neck

20. **The Throat.** A slash across the throat from the rear severs the windpipe and jugular vein.

21. **The Subclavian Artery.** The subclavian artery is approximately 2 1/2 inches below the surface between the collarbone and the shoulder blade. Attack this spot with a thrust by gripping the knife as depicted in picture. As you withdraw the knife, slash to make the wound as large as possible. This artery is difficult to hit, but once it is cut, the bleeding cannot be stopped and your opponent will lose consciousness within seconds. Death will follow rapidly.

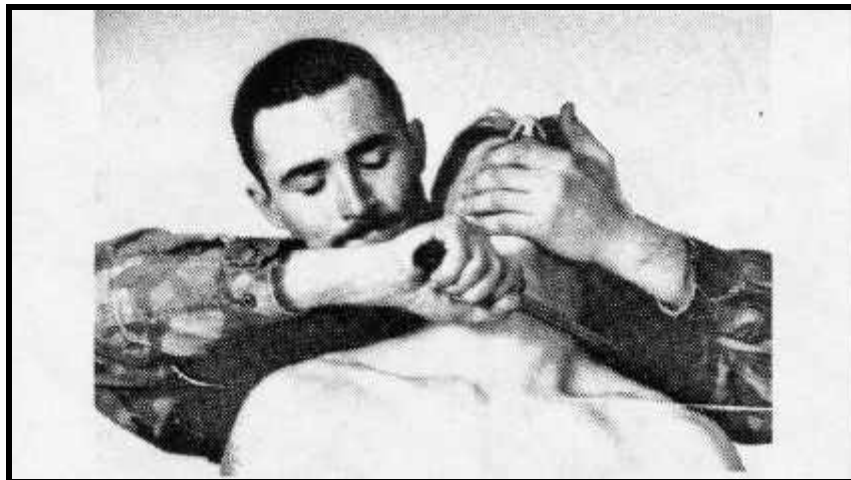

Figure 10-15 Throat



Figure 10-16 Subclavian Artery

DEFENCE AGAINST KNIFE ATTACK

22. **Avoid Close Contact.** The first line of defence against an opponent armed with a knife is to avoid close contact. It is dangerous to attempt to disarm your opponent by hand, as such a technique is an advanced skill.



Figure 10-17 Defend Yourself with any Available Object such as a Stick

23. **Disarm Your Opponent.** Any opponent, regardless of skill with a knife, is dangerous. For this reason, you must disarm him with the safest and most effective method. The following methods are recommended:

- a. Use an object to aid your attack such as a heavy stick or similar available weapon. Attempt to knock or kick the weapon from your opponent's hand.
- b. Use a piece of your equipment as a weapon such as your helmet. Hold the chin strap and swing it toward the knife to knock it out of your opponent's hand. You can also use a web belt with canteen to swing as a weapon. A combat coat or poncho can be used to cover or muffle the force of a knife blow.
- c. You can scoop up sand or dirt from the ground and throw it into your opponent's eyes. Use an underhand motion to scoop and throw in the same

motion. This action will temporarily blind him and enable you to counterattack. Any of the above actions will gain time for you to seize the initiative and attack with a weapon, kick, or other appropriate means of attack.



Figure 10-18 Use of Jacket to Aid Countering Knife-Attack



Figure 10-19 Use of Webbing to Counter Knife-Attack



Figure 10-20 Disarming Attacker with Knife

24. **Advanced Techniques.** If the above techniques are not possible and there is no opportunity to attack with a knife, the following counters are to be used:
- a. A counter to the downward stroke is an upper block. Immediately after the momentum is stopped, you must grab the wrist in which the knife is being held. You can then apply striking techniques until the opponent is beaten. At not time should you release the wrist in which the knife is being held. Your techniques must be fast, sure and violent.
 - b. A counter to the upward stroke is shown in the picture following. Catch your opponent's wrist or forearm in the palm of your hands. At the same time, glide slightly to the rear to keep the knife from cutting your stomach. Upon stopping his blow, grab your opponent's hand and place your thumb on the back of his hand. Reinforce this hold by grabbing his wrist and place your thumb on the back of his hand. Reinforce this hold by grabbing his wrist and place your thumb on the back of his hand. Twist his wrist and bend his hand toward his forearm, causing him to release the knife. Finish the technique by stabbing your opponent in the kidney.



Figure 10-21 Counter to Knife Attack



Figure 10-22 Downward Counter to Knife Thrust



Figure 10-23 Relieving Opponent of Knife

CHAPTER 11

DEFENCE AND COUNTERS

STEPS IN COMBINING BLOCKING TECHNIQUES WITH DECISIVE COUNTER ATTACKS

1. Begin by pre-arranging the specific techniques you will use to block and counter your partner's attack. This formal method of practicing is a necessary preliminary to more advanced practice.
2. Pre-arrange your response to your partner's attack, but concentrate on improving your timing and speed in shifting from block to counterattack. Emphasize speed and coordination.
3. After attaining proficiency in the method, it is no longer necessary to choose your counterattack in advance. Instead, at the instant you block, base your choice of counter on your stance and on your position in relation to that of your opponent. For example, if your block is late, select a counter technique which lends to a delivery of above average speed. Learn to make split-second decisions of this kind.

IMPORTANT CONSIDERATIONS

4. **Position of Eyes.** Keep your eyes on the centre of the triangle formed by the opponent's shoulders and eyes, If you concentrate on his hands or feet, you may become confused or distracted.
5. **Movement of Feet.** Move your feet lightly and quickly. Slide smoothly over the ground. When stepping forward, be sure also to thrust your hips forward.
6. **State of Mind.** Avoid showing fear when the opponent attacks. Apply your techniques with confidence.
7. **Application of Power.** Be prepared to focus all available power whenever necessary. After it has served its purpose, instantly release the tension. Practice each technique repeatedly, sometimes stepping forward and sometimes to the rear. Your body will gradually grow accustomed to the required movements.

DEFENCE AND COUNTERS FROM UPPER ATTACKS

8. See Figures 11-1 to 11-4.

DOUBLE INSIDE BLOCK TO FRONT KICK

9. See Figures 11-5 to 11-7.

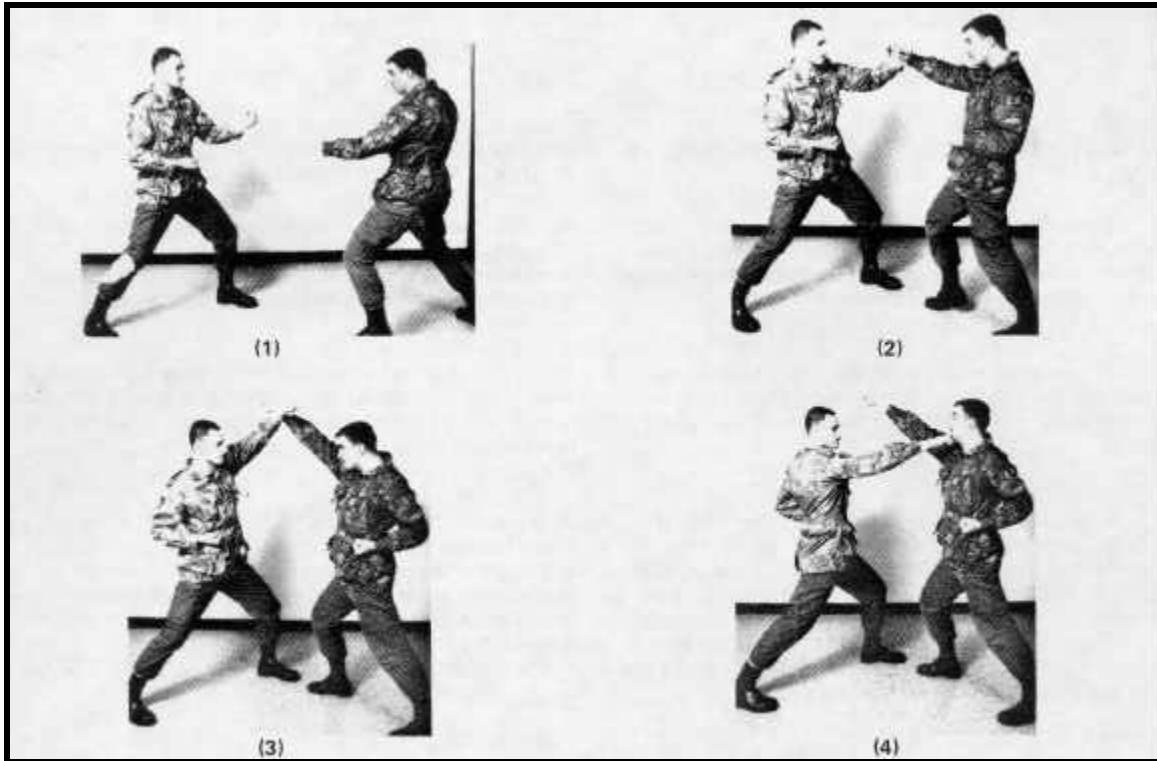

Figure 11-1 Counter to Upper Attack

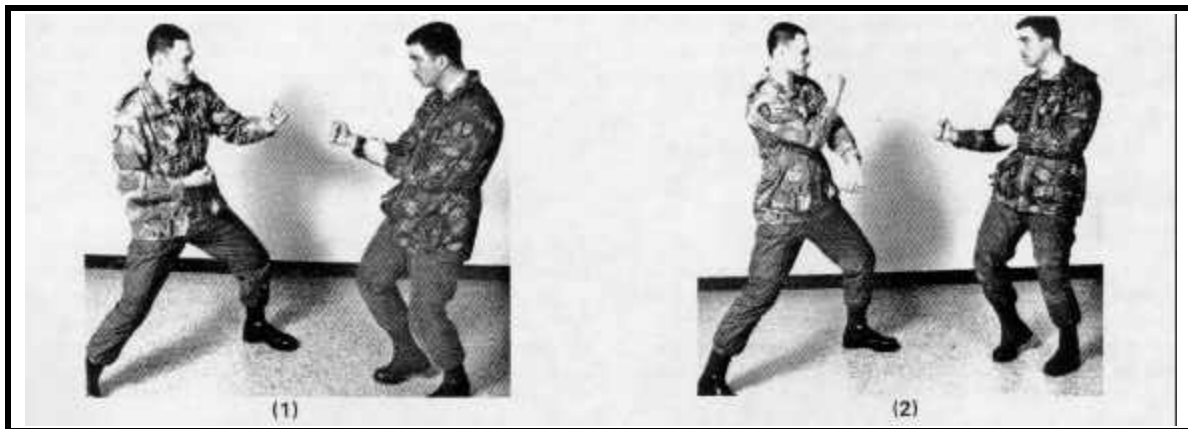

Figure 11-2 Deception Move



Figure 11-3 Elbow Smash Counter Sequence

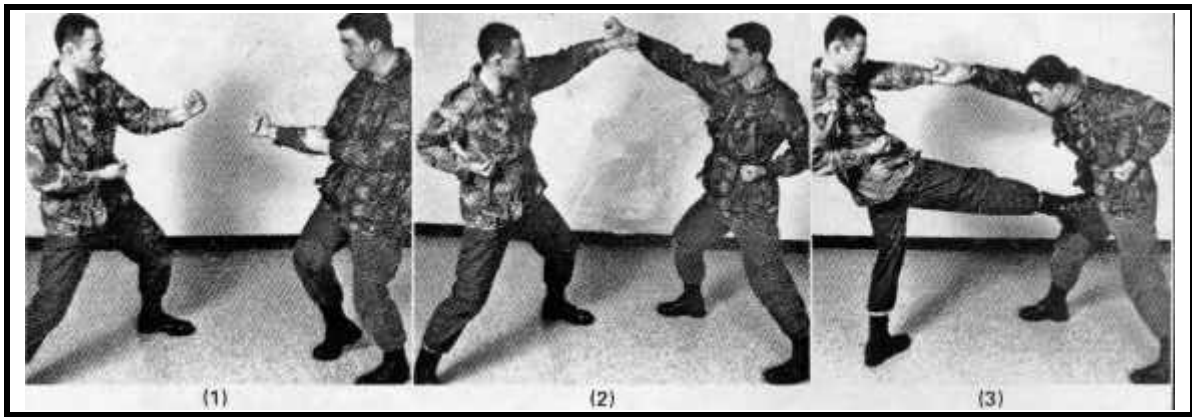

Figure 11-4 Upper Block Front Snap Kick (Relatively Close Range)

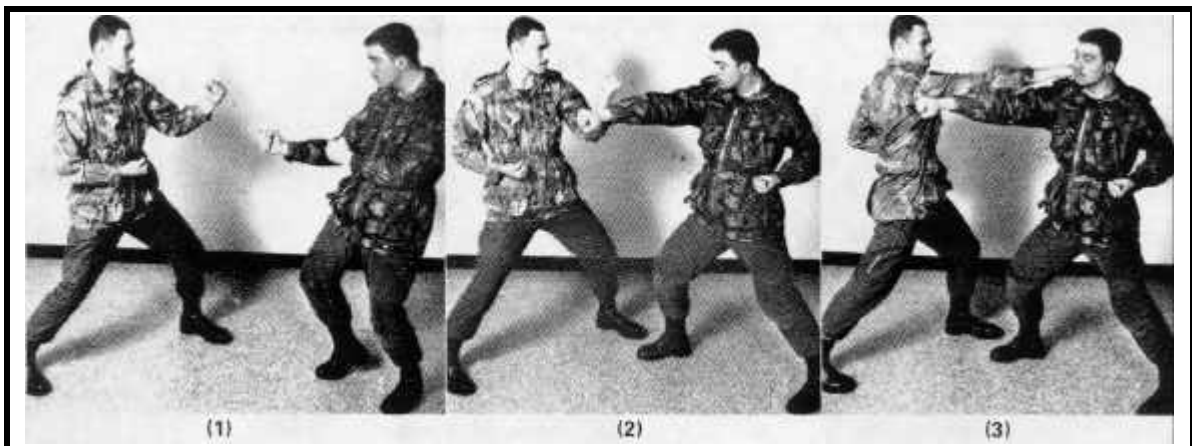

Figure 11-5 Block from Outside Inward with Bottom of Wrist to Reverse Punch (Ordinary Distance)

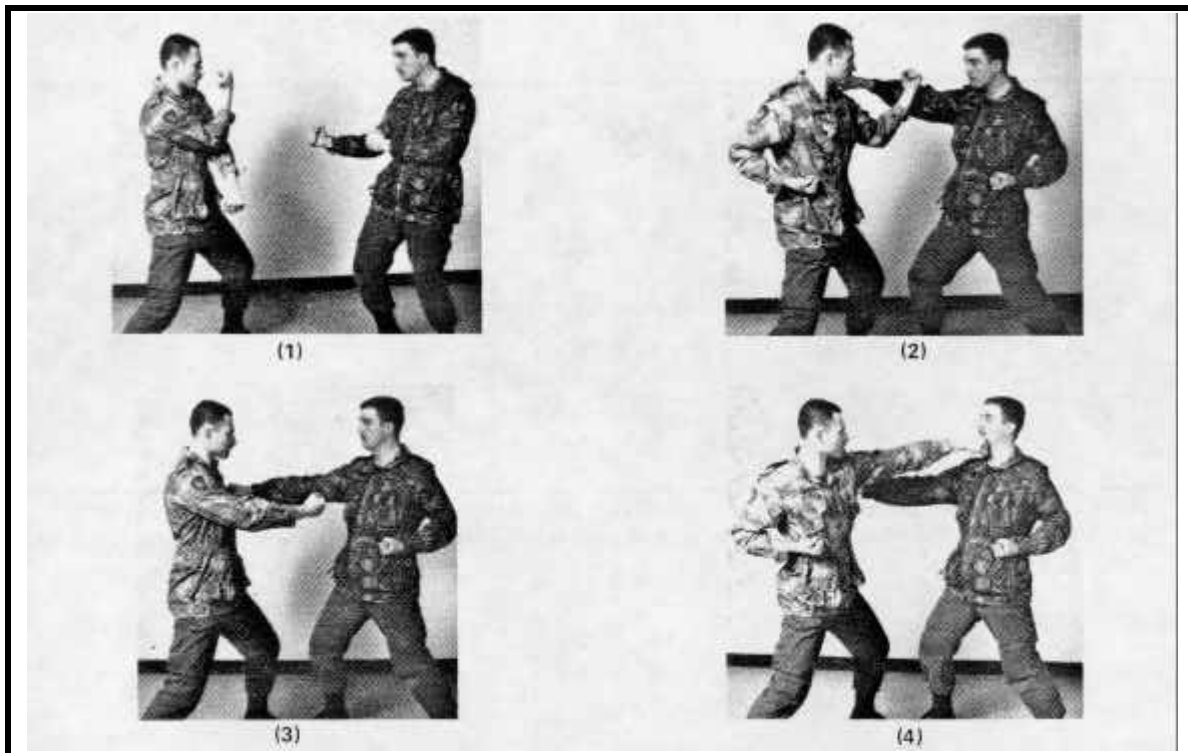

Figure 11-6 Block from Outside Inward with Bottom of Wrist to Elbow Strike (Closer than

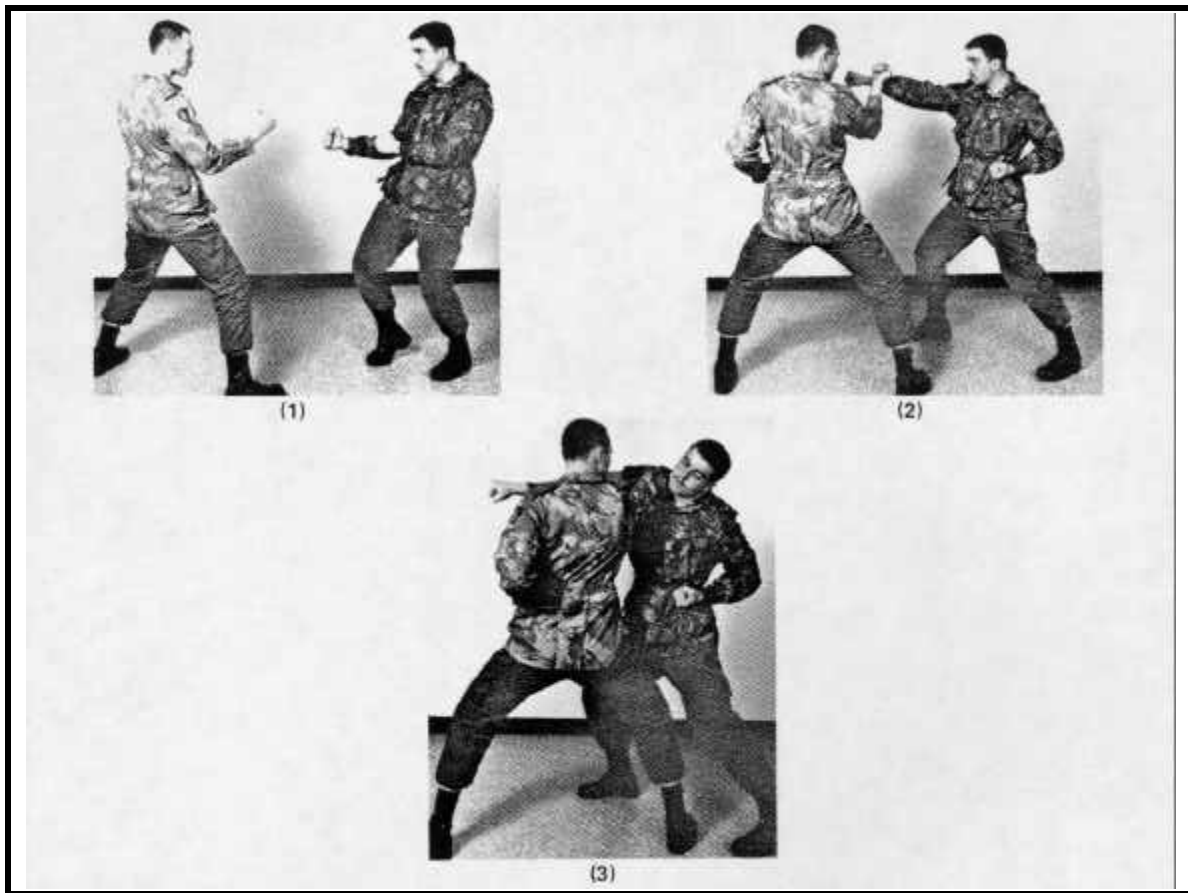

Figure 11-7 Block from Outside Inward with Bottom of Wrist to Elbow Strike (Closer than Normal Distance)

CHAPTER 12

BASIC TRAINING DRILLS

GENERAL

1. Training in individual techniques can take the form of consecutive forward or rearward steps. For instance, lunge-punch practice is usually done by repeating the technique in five separate forward steps, turning, and again punching and stepping five times in the opposite direction. This practice can be repeated endlessly. Pause after each movement to be sure your stance is strong and well balanced and that your attack is correctly aimed. Training in consecutive rearward movements is especially important in the case of blocking techniques.
2. After attaining some proficiency in the performance of individual techniques, begin training for the application of combination techniques. For example, the upper block might be followed by a reverse punch.
3. When practicing combination techniques, move from one technique to the next with maximum speed. However, your techniques will be ineffective, and your training of little value, if you sacrifice power and correctness of form for quick execution. For example, it is obvious that a stable, strong stance is required for the delivery of effective offensive or defensive techniques. Yet, students appear to ignore this fact when they try to move too quickly from one technique to the next. Work slowly at first. As your skill increases, gradually increase the speed of your techniques and reduce the interval of time between them.
4. Another important point in combination techniques concerns the use of the hips. If you move from one technique to the next too quickly to allow proper hip rotation, your techniques will be weak. Moreover, it has been demonstrated that when the hips are fully rotated in one direction, they automatically tend to rotate in the reverse direction. Utilize this reaction to increase the effect of the follow-up technique. For instance, use hip rotation when moving from the round kick to the back-fist strike. Delivered in this way, the back-fist strike will be more powerful than if individually applied.

LUNGE PUNCH

5. Assume the downward block position with your body in fighting stance.

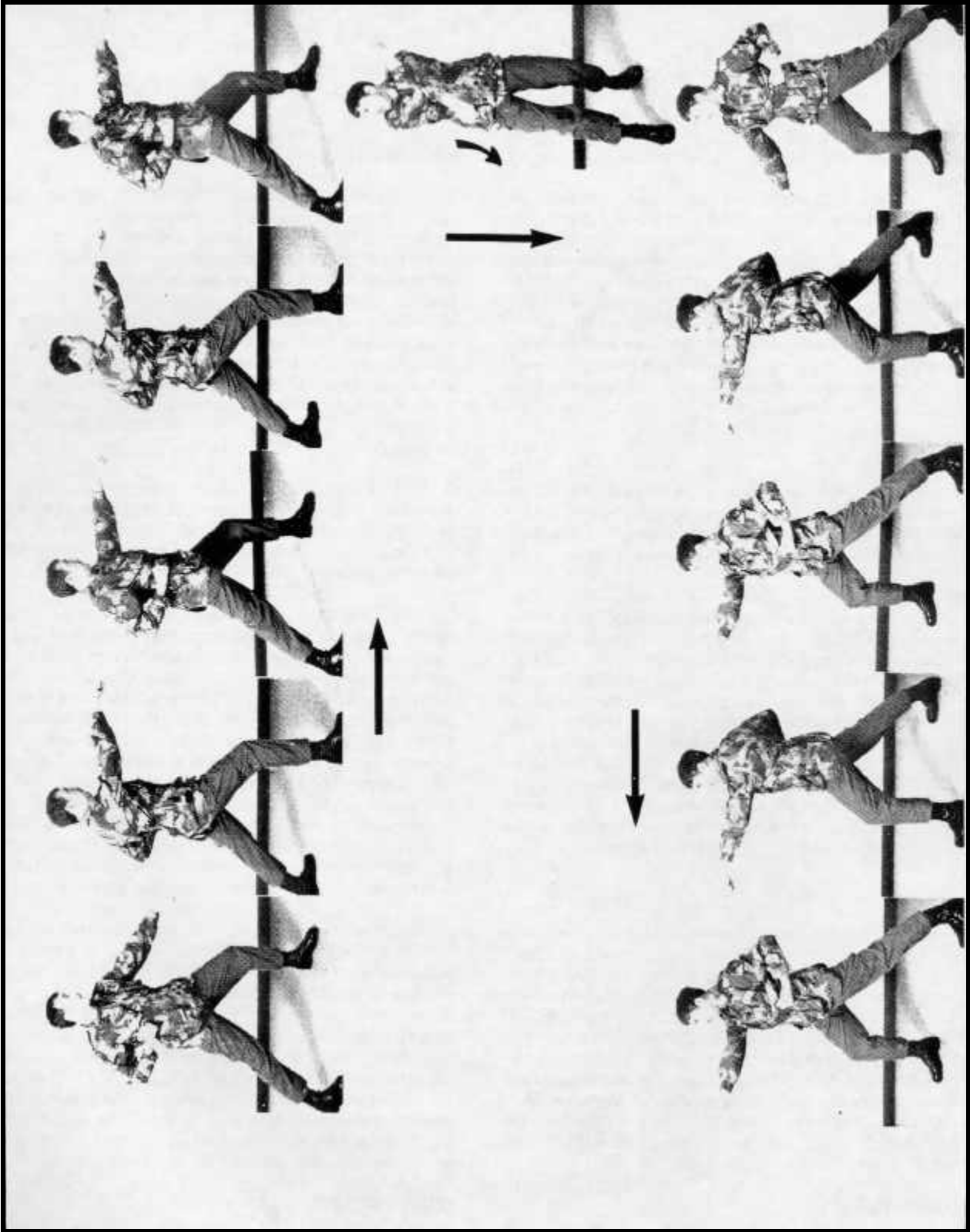

Figure 12-1 Basic Training Movements

6. Step forward and deliver the lunge punch with your right arm.
7. Advance a step and deliver another lunge punch with your left arm.
8. Continue advancing until you have completed total of four steps and four alternate punches.
9. Upon completion of the fourth step, turn around by shifting your rear foot to the left and pivoting on your front foot. Assume the downward block position in fighting stance.
10. Advance in the opposite direction and practice the lunge punch in the same manner described above. Continue this sequence as many times as desired.
11. It is also necessary to practice the lunge punch while retreating.
12. As the soldier becomes familiar with this exercise, include a reverse punch with each lunge punch.

UPPER BLOCK

13. Assume the downward block position in fighting stance.
14. Step forward and deliver the upper block.
15. Continue advancing until you have completed four consecutive steps and four blocks.
16. Turn around and assume the upper block position in fighting stance.
17. Resume your practice by advancing four steps in the opposite direction.
18. As the soldier becomes familiar with this exercise, include a reverse punch with each block.

FOREARM BLOCK TO ELBOW STRIKE

19. Assume the downward block position at fighting stance.
20. Step forward and deliver a forearm block.
21. Shift to straddle-leg stance and apply the elbow strike.

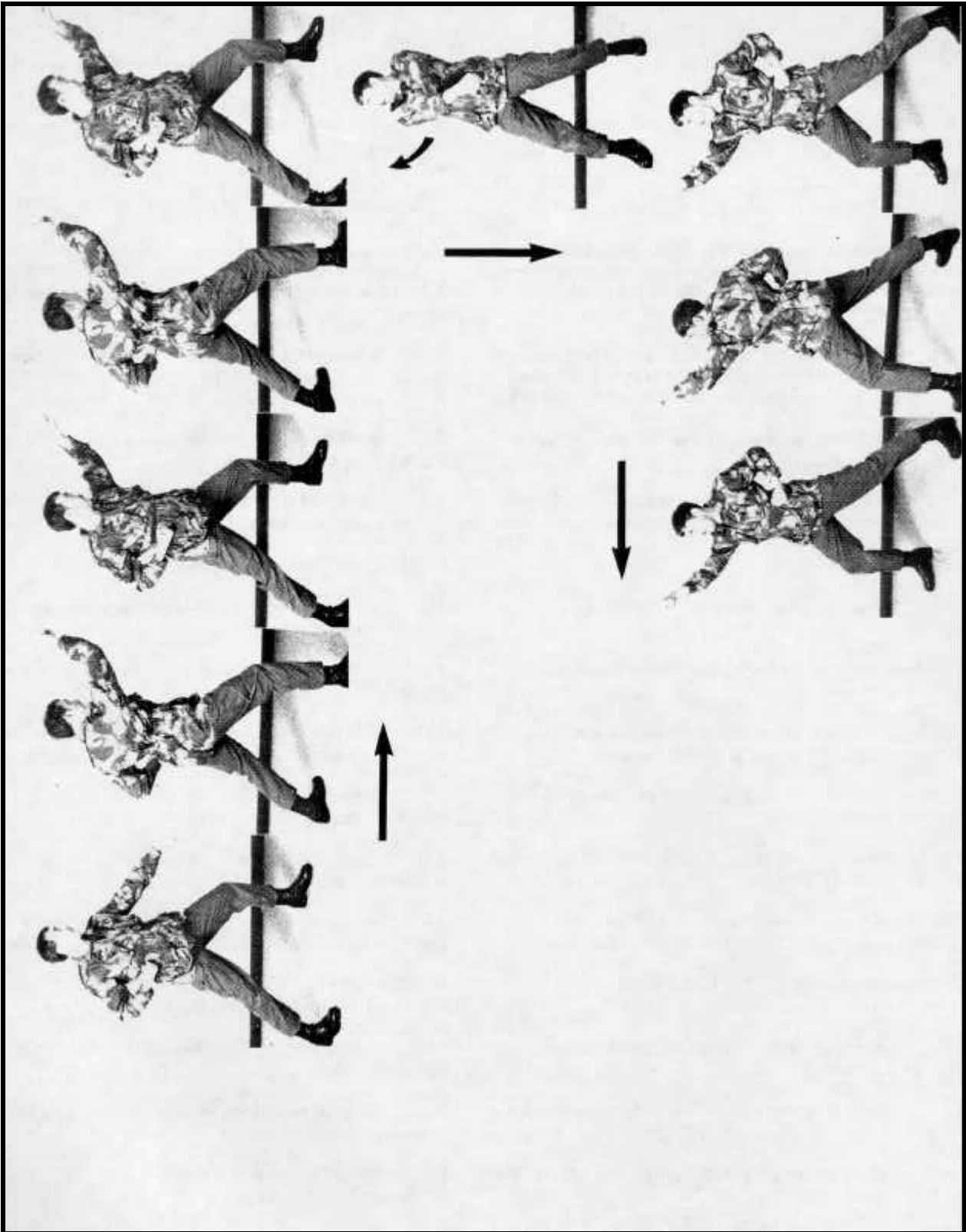

Figure 12-2 Lunge Punch Training Movements

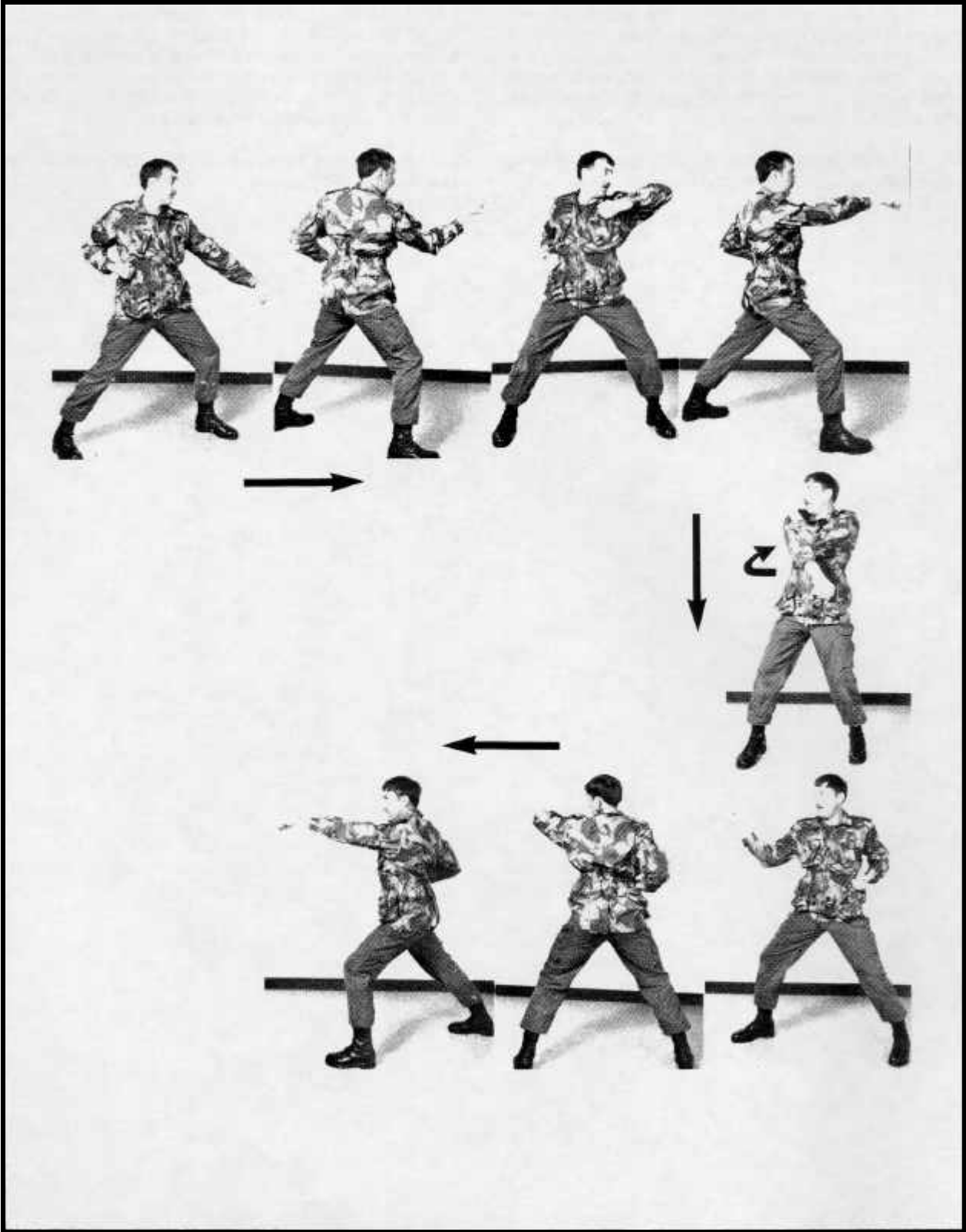

Figure 12-3 Upper Block Training Movements

22. Continue alternate blocks and counters, stepping forward each time you apply a forearm block and move to the straddle-leg stance when you apply the elbow strike. Whenever you practice blocking techniques, be sure to perform the block while retreating as well as while advancing.

23. As the soldier becomes familiar with this exercise, include a reverse punch after each elbow strike.

CHAPTER 13

SPECIAL TECHNIQUES

STRANGULATION

1. Any material which is strong, thin and relatively pliable can be used as a weapon for strangulation. These weapons are commonly referred to as Garrots. Wire is preferred because it can decapitate your opponent.

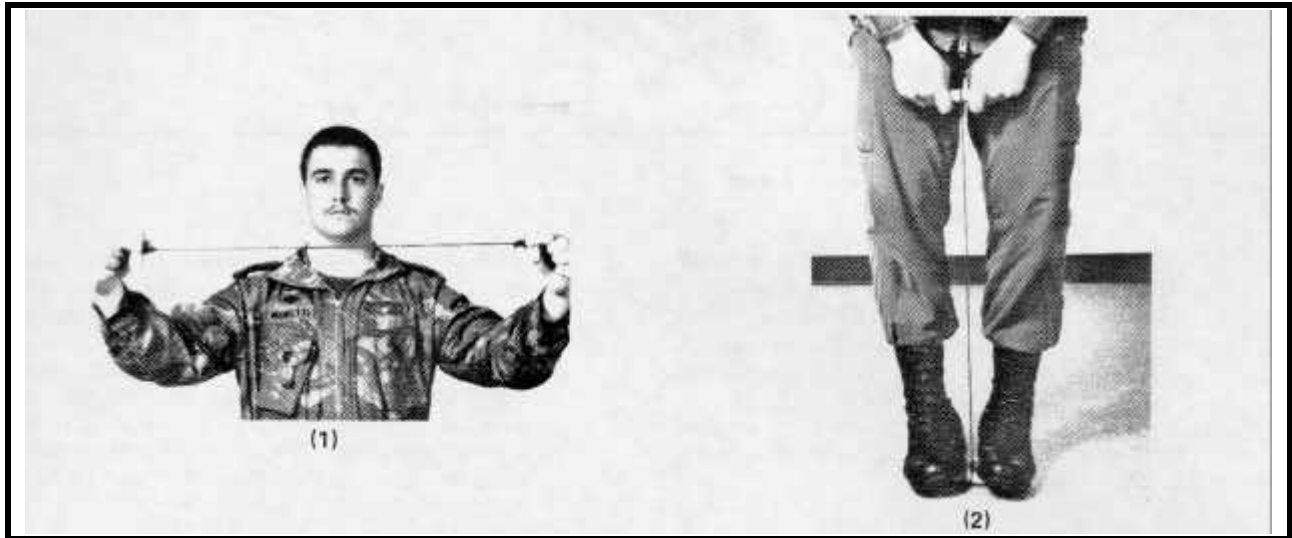

Figure 13-1 Garrot

2. **Strangulation with Cord or Wire, One-Hand Loop -**

- a. For this method of strangulation you need a piece of flexible wire or a piece of cord about three feet in length, such as a bootlace. Approach your opponent from the rear, holding the wire or cord ends in each hand. Toss it over his head from his left and place the heel of your right hand, still holding the end of the cord, on his shoulder near the nape of his neck. See Figure 13-2.
- b. At the same time, place your knee (either one) in the small of your opponent's back and yank the cord or wire with your left hand while pushing with your right hand. If this is done quickly, your opponent cannot cry out (see Figure 13-2). You can tie the ends of the cord or wire around two short sticks for better handholds.
- c. Hold your garrot in both hands. Throw both hands over opponent's head and ensure the garrot is on his neck. Turn 180 degrees from the opponent ensuring you cross the garrot. Flip the opponent to the ground violently and continue the pressure. You may cause unconsciousness or death depending on the force used and the length of time the hold is applied. See Figure 13-3.

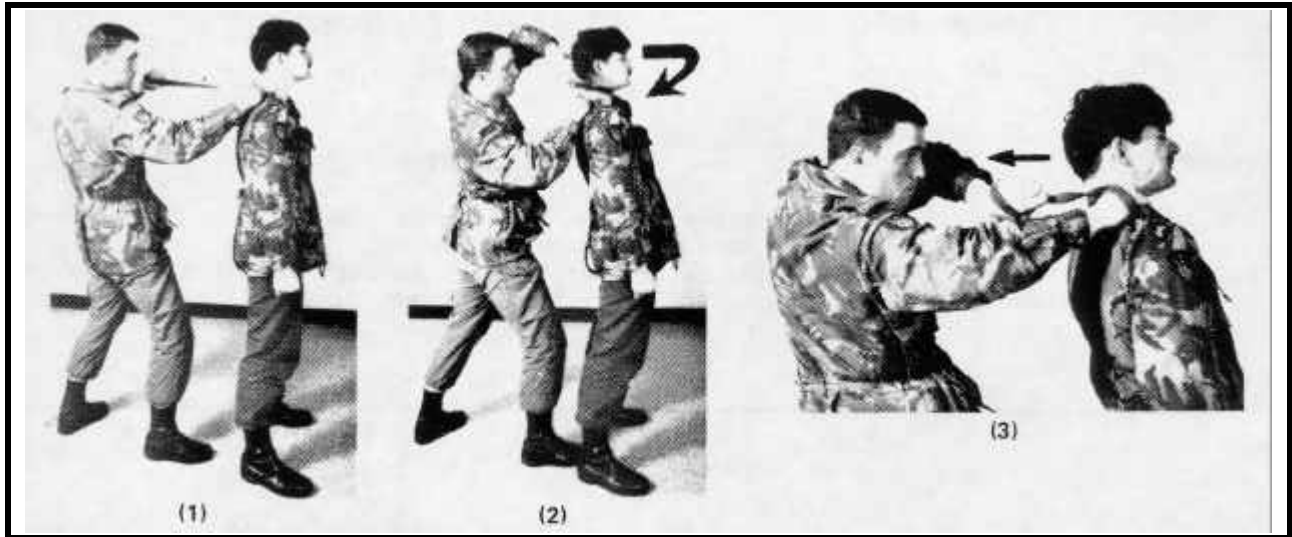

Figure 13-2 Strangulation Using a Garrot



Figure 13-3 Rearward Approach with Garrot

3. Strangulation with Cord or Wire, Two-Hand Loop -

- a. Hold the wire or cord ends in each hand. Place your left forearm across the back of your opponent's neck. Swing your right arm over your opponent's head from his right, looping the cord in front of his throat.
- b. Complete the loop and jerk your arms sharply in opposite directions, tightening the loop and strangling your opponent. Quick application of this method prevents your opponent from crying out. You can cause unconsciousness or death, depending on the force used and the length of time the hold is applied.



Figure 13-4 Two Hand Loop Strangulation

HELMET NECK BREAK

4. Grab the front rim of your opponent's helmet with your left hand. At the same time, place your right forearm against the back of his neck and place your right hand on his left shoulder.
5. Holding firmly to the front rim of your opponent's helmet, pull his helmet up, back, and down, and drive your right forearm forward. Your right forearm, under the back edge of his helmet, acts as a lever against which his neck is broken. This method is possible only when your opponent's helmet strap is fastened underneath his chin. See Figure 13-5.

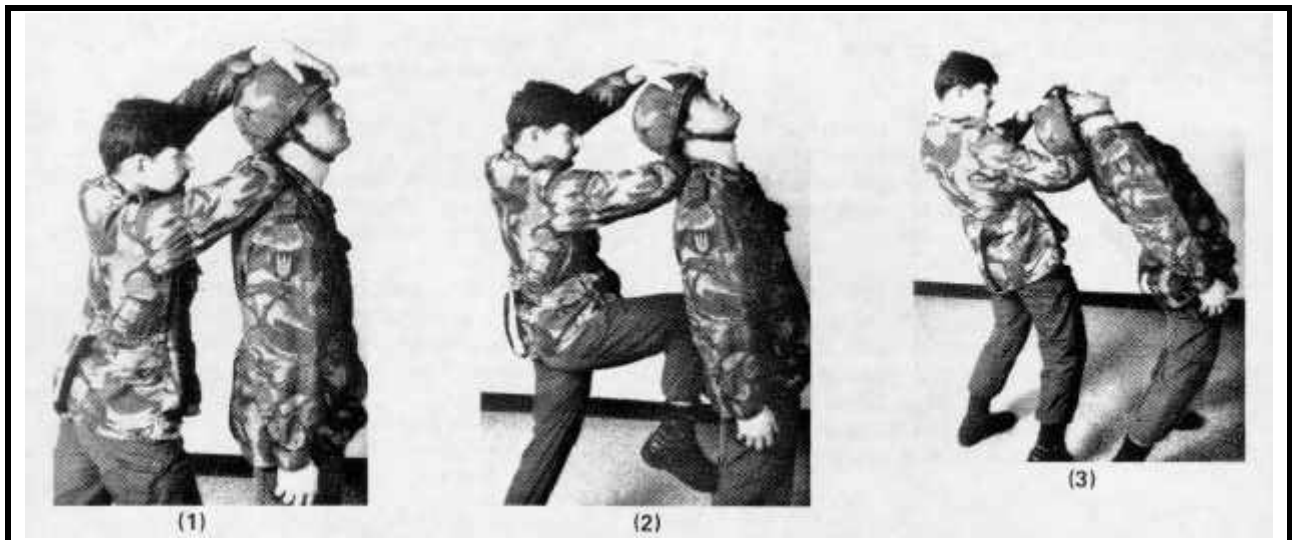

Figure 13-5 Helmet Neck Break

HELMET SMASH

6. If you see that your opponent's helmet strap is not fastened, or discover this when attempting the helmet break, silence him with a helmet smash. Snatch your opponent's helmet from his head. While doing this, grab his collar or shirt with your other hand, jerking him off balance to his rear.

7. Now smash the helmet on the back of his head or his temple. Your opponent may have a chance to yell when this method is used.



Figure 13-6 Helmet Smash

CROTCH TAKE DOWN

8. See. Figure 13-7.

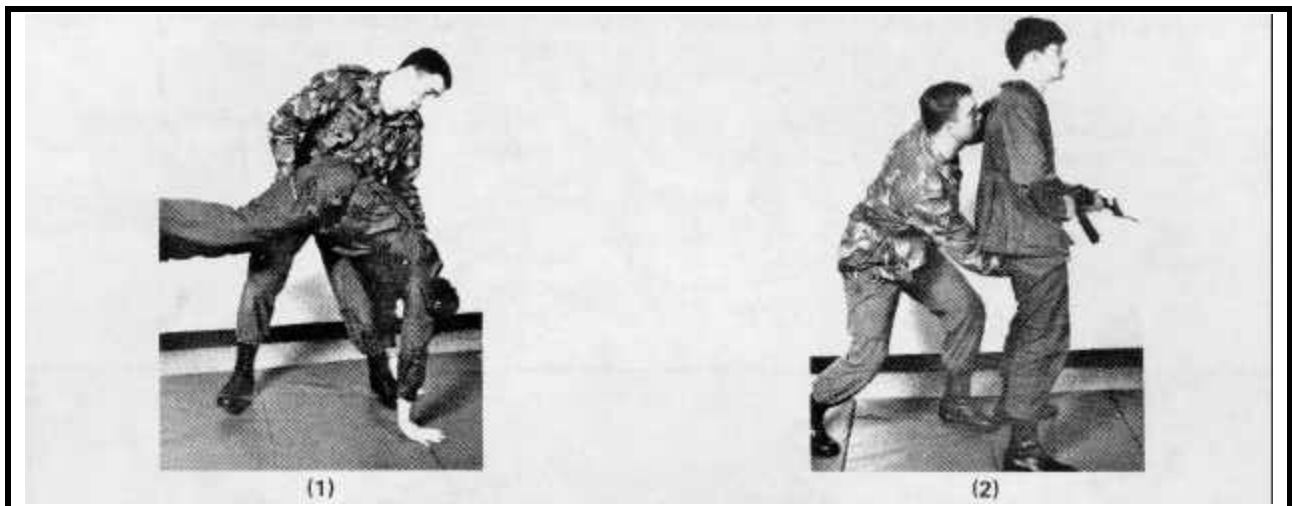

Figure 13-7 Crotch Take Down

AVAILABLE WEAPONS

9. Striking an opponent on his spine with a blunt object to stun him and striking him with a sharp object to kill him; and
10. Use of the homemade blackjack.

REAR TAKE-DOWN

11. To take down a sentry from behind, simply grasp both ankles and pull backwards. The opponent will fall forward with his face hitting the ground.

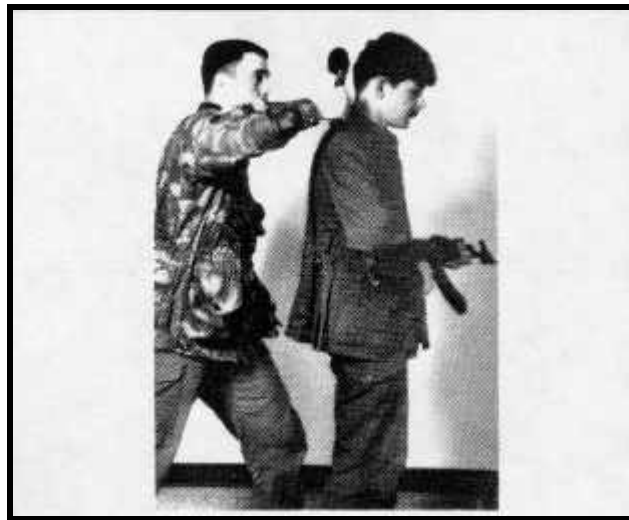

Figure 13-8 Homemade Blackjack

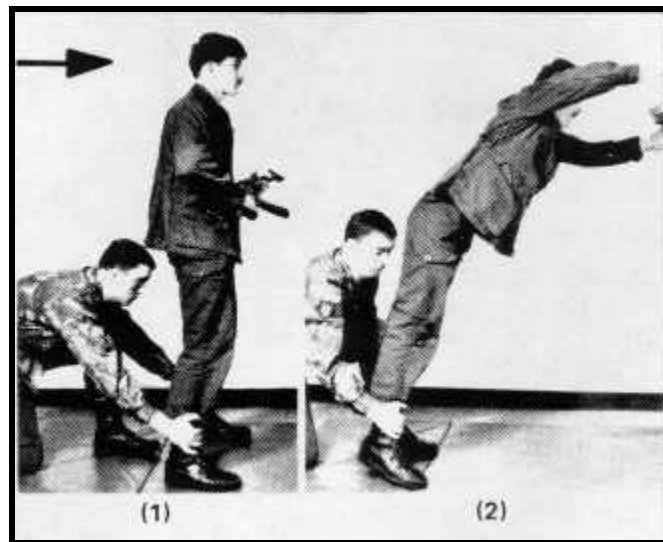

Figure 13-9 Rear Take-Down

RIFLE AT YOUR BACK

12. Note which hand is at the trigger.
13. Swing the opposite arm down to deflect the rifle and pivot to face your opponent.
14. Close with your opponent immediately to ensure he cannot shoot or strike you with the weapon.
15. Apply strike to disable your opponent.

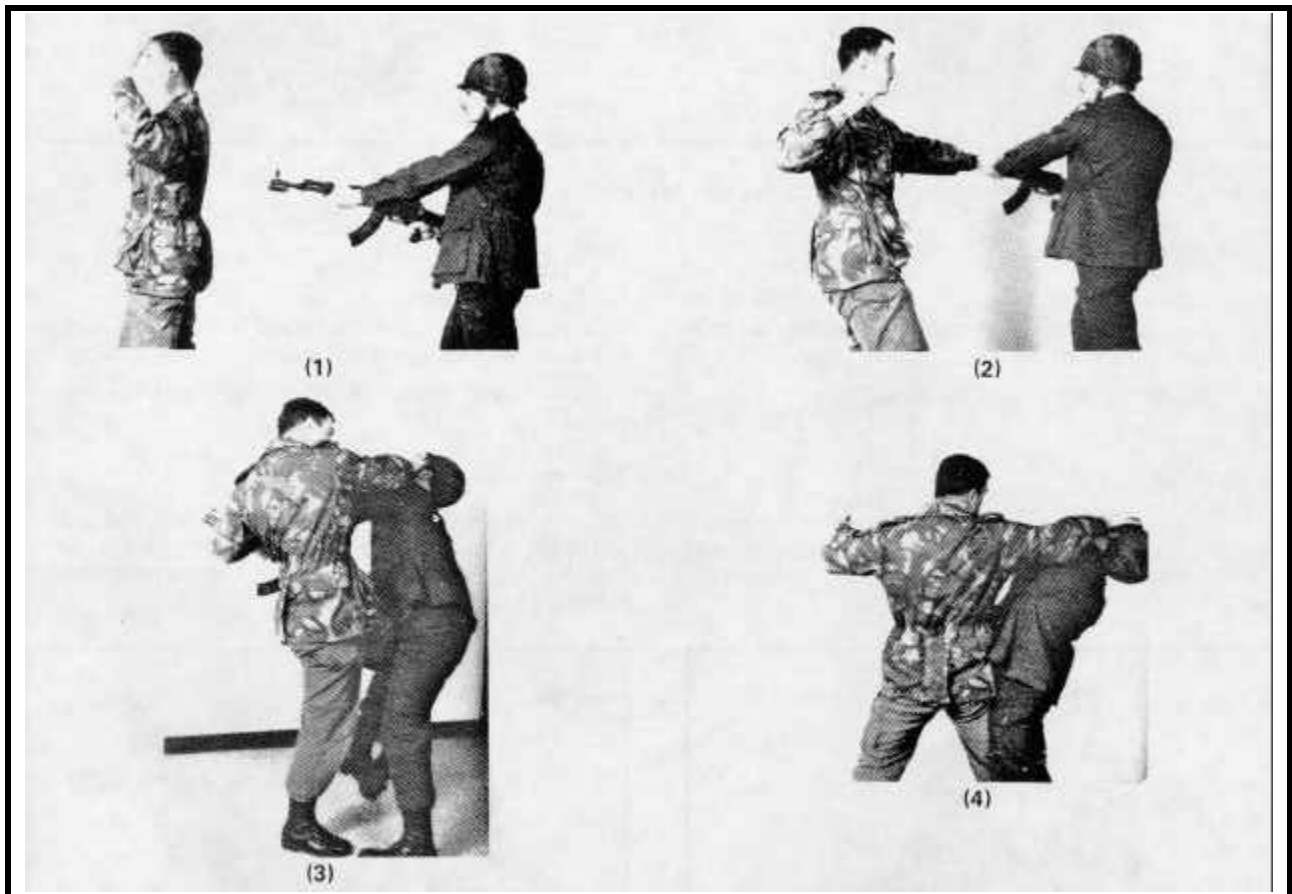

Figure 13-10 Rifle at Back

RIFLE IN FRONT

16. Note which hand is at the trigger.
17. Push the rifle to the side with the same hand and immediately close with your opponent.
18. Execute strikes to disable your opponent.

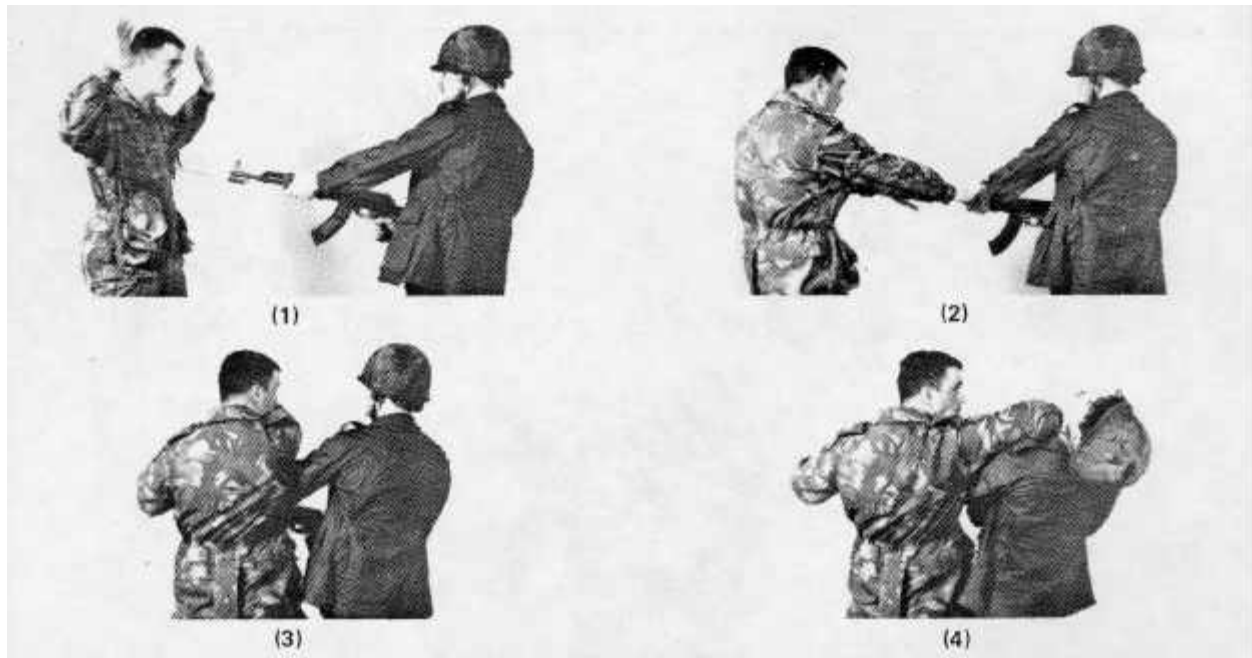

Figure 13-11 Rifle in Front

PISTOL IN BACK

19. Note which hand has pistol.
20. Swing the opposite arm down to deflect the pistol outward while simultaneously pivoting around in the same direction.
21. Ensure you close with the opponent and control his gun hand.
22. Execute strikes to disable your opponent.

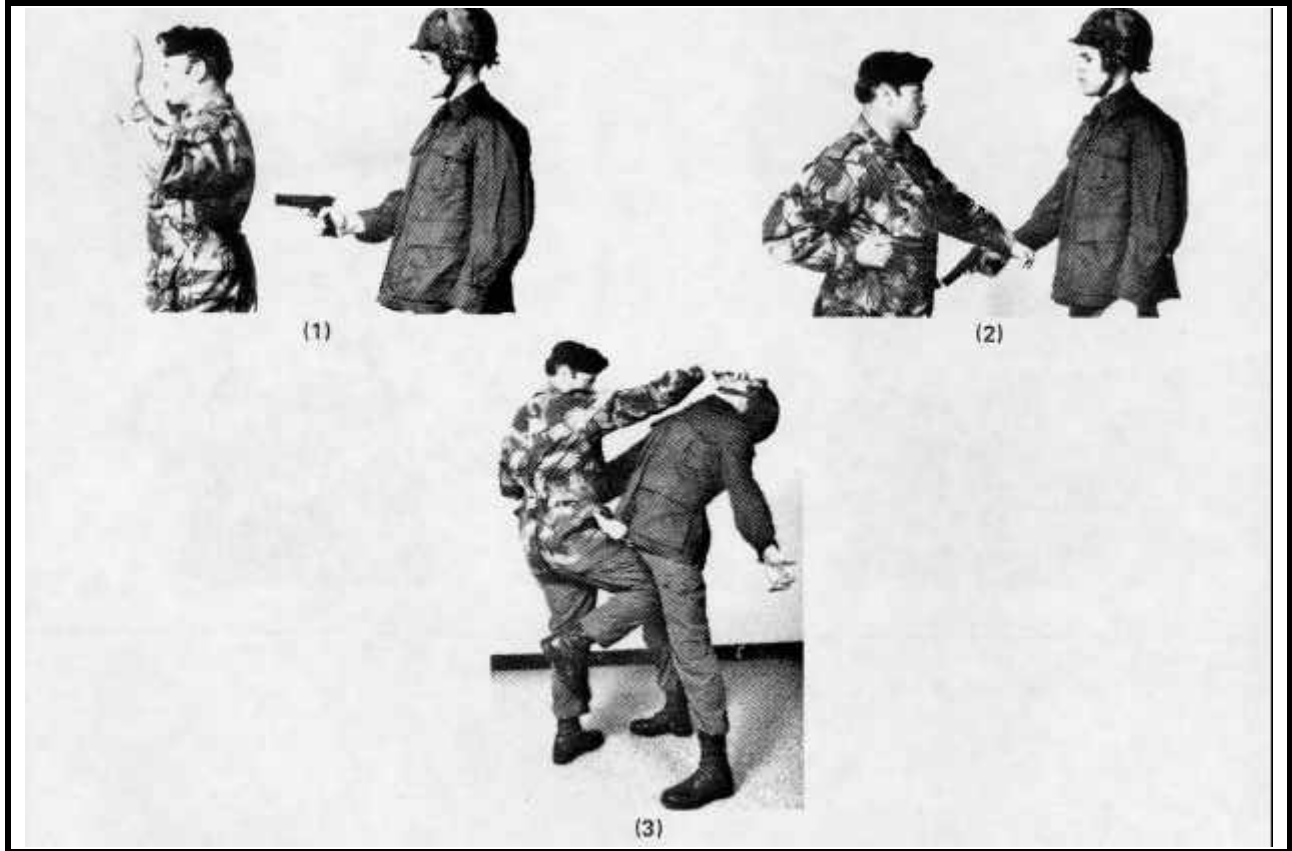

Figure 13-12 Pistol in Back

PISTOL IN FRONT

23. Note which hand has pistol.
24. Push the gun aside with the opposite hand while simultaneously pivoting 90 degrees to present a smaller target. Ensure you control the gun hand.
25. Execute strikes to disable your opponent.

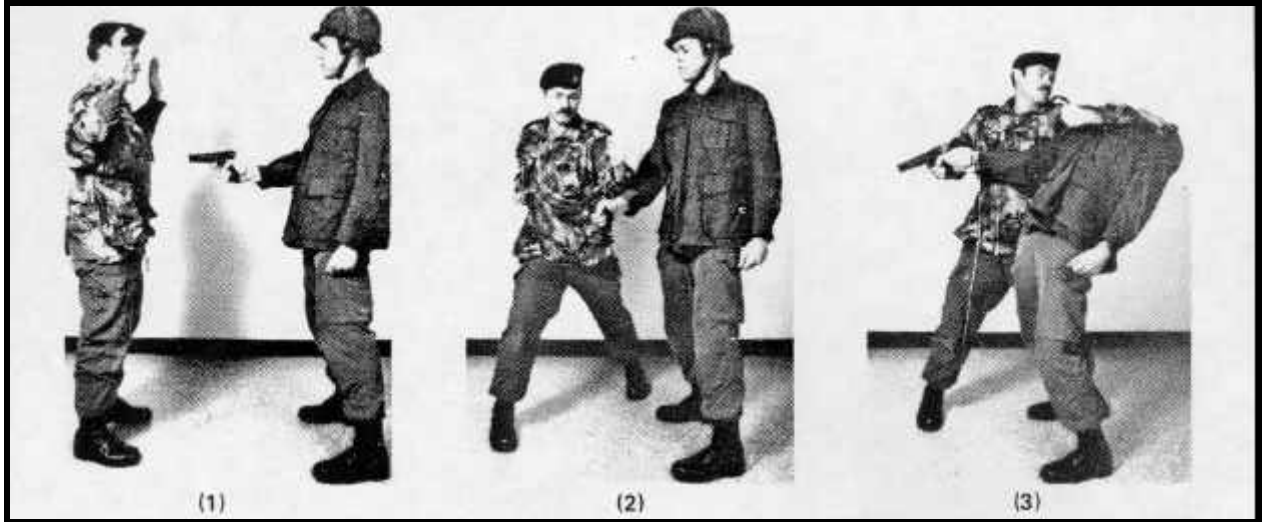

Figure 13-13 Pistol in Front

POINTS ABOUT RIFLES AND PISTOLS

26. If you can't reach the pistol or rifle with a fast hand movement, don't try it. Hopefully, you'll get the chance later.

27. Always pivot away from your opponent, If you pivot into him, the pressure will probably cause him to pull the trigger by reflex.

28. Always deflect the front part of the rifle toward the trigger hand. If you deflect in the other way, you probably will get a butt stroke.

CHAPTER 14

HAND-HELD WEAPONS

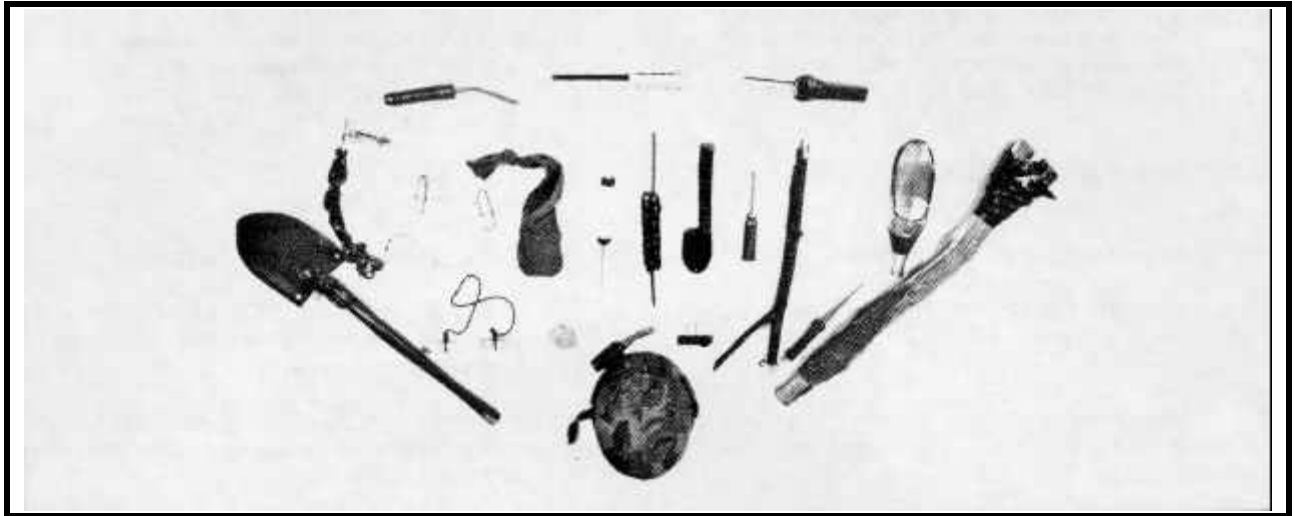

Figure 14-1 Various Hand-Held Weapons

GENERAL

1. The good hand to hand fighter can find several objects to help him in this attack and is limited in the use of available weapons only by his own imagination. There are several objects which usually are available to the soldier on the battlefield. Examples are as follow:

- a. **Steel Helmet.** See Special Techniques;
- b. **Web Equipment.** Full web equipment is usually heavy and could be used to ward off an armed opponent or possibly disarm him;
- c. **Entrenching Tool.** This tool can be used to deliver deadly or disabling blows to the opponent's body;
- d. **Sand or Dirt.** Thrown at a charging opponent, could upset his attack. It could also create an opening during your attack; and
- e. **Pen/Pencils.** Stab to the eyes, face and stomach.

2. If an opportunity arose where the soldier had time to arm himself, ie, escape and evasion, he could make the following weapons:

- a. **Make-shift Knives.** Tape a handle to a six or eight inch spike. The spike could be molded into a sharp edge by placing the spike on a railway track. Once flat, the edge could be honed on a sandstone. Use also long narrow pieces of steel such as hacksaw blades;
 - b. **Wire Garrote.** See Special Techniques;
 - c. **Sharpened Sticks/Clubs/Spears;** and
 - d. **Two short sticks.** If attached together by a short piece of rope, will make an effective weapon.
3. These are only a few suggestions. Students will be asked to produce various weapons and practice their application.

CHAPTER 15

BAYONET/PUGIL STICK FIGHTING

GENERAL

1. Bayonet fighting is a technique that an infantry soldier must master. Training to perfect this technique develops skill, confidence and aggressiveness in executing the movements.
2. Two main methods are used for the training:
 - a. the rifle with bayonet, which will be used against dummies and/or practice targets spaced on the terrain to simulate combat; and
 - b. the pugil stick, which increases realism by introducing blocking, movements, feinting and counter-attacking. It is the ideal way to sharpen reflexes and increase aggressiveness in combat.
3. This chapter deals mainly with bayonet training methods and combat techniques. It also covers pugil stick training methods and combat techniques. These two disciplines must not be separated. They form part of a logical process in bayonet fighting training.

NOTE

Bayonet targets must be made of soft material to avoid damage to the rifle barrel and to the bayonet. A ground target can be represented by an earth-filled sandbag. A standing target can be made from hessian, or other suitable cloth, filled with straw, foam rubber or horse hair packing. During field firing training, sandbags should be provided beside each enemy trench, and soldiers instructed to bayonet these, and not the wood and cardboard figure targets.

PRINCIPLES

4. **Aggressiveness.** The bayonet is an offensive weapon that must be used aggressively. Any hesitation, delay or useless movement may be fatal. Therefore, the infantry soldier will attack violently until the enemy surrenders or has been overpowered.
5. **Quickness.** The bayonet fighter must know how to detect an opponent's slightest weakness and exploit it instantly. If the opponent protects too well, the fighter must parry the weapon and strike the opponent with the bayonet. or the butt of the rifle as violently as possible.

6. **Vulnerability.** Although all parts of the body can be a target, the face and throat are most vulnerable because the adversary will react instinctively to try to protect them against the point of the bayonet, often leaving other vulnerable parts such as the chest, abdomen and groin unprotected.

BASIC BAYONET MOVEMENTS

7. **On guard and rest.** The on guard and rest positions are used only in training. They are not attack movements.

- a. **On guard.** At the command on guard, the soldier moves one foot about 16 inches forward and raises the rifle in a natural fighting position. The soldier holds the rifle firmly, with one hand on the stock and the other on the pistol grip or throat of the butt. The soldier leans slightly forward, keeping good balance and watching the adversary closely; and
- b. **Rest.** At the command rest, the soldier puts the butt of the rifle between the feet and holds the weapon vertically, with both hands around the end of the stock.

8. **Point.** The point is the main attacking movement. The soldier usually executes this movement from the on guard position (Figure 15-1) at about 1.5 m from the adversary. The point is directed against a vulnerable part of the body, ie, the throat, face, abdomen or chest. To execute this movement, proceed as follows:

- a. Seize the weapon firmly and thrust the bayonet vigorously into the enemy. Put the weight of the body behind the thrust and advance the rear foot when the point strikes the enemy. The point is usually executed when in motion and either foot may be forward; and
- b. To extract the bayonet, pull the rifle straight back until the blade is out. After sticking the bayonet into an enemy on the ground, it may be necessary to place one foot on the victim to extract the weapon.



Figure 15-1 On Guard



Figure 15-2 Rest



Figure 15-3 Point, Enemy Standing



Figure 15-4 Point, Enemy on the Ground

9. **Left and right parry.** The parry is a defensive movement that is used to turn aside an adversary's weapon and make the enemy vulnerable. From the on guard position, strike your adversary's rifle to the left or right with sufficient force to ward off the weapon. A parry must be followed immediately by an attacking movement.

10. **Horizontal Butt Stroke.** The horizontal butt stroke usually follows a left parry. Swing the rifle, directing the lower end of the butt at your adversary's head or upper body. Put the weight of your body behind the blow and bring the rear foot forward as you deliver it. A butt stroke may very likely only stun your adversary and therefore must be followed by a slash and/or point.

11. **Vertical butt stroke.** The vertical butt stroke may be executed in the on guard or crouching position. To execute a vertical butt stroke, move the rear foot forward and, at the same time, bring the butt up in a vertical arc towards the adversary's groin, solar plexus or chin. Place the entire weight of the body behind the blow.



Figure 15-5 Extraction of Weapon



Figure 15-6 Left Parry



Figure 15-7 Right Parry



Figure 15-8 Horizontal Butt Stroke

12. **Smash.** The smash may be employed effectively when the enemy is backing up to avoid a vertical butt stroke. Hold the rifle higher than the shoulder with the butt forward and the pistol grip upward. Push the body forward off the rear leg and direct the butt straight into your opponent's face. This movement can also be used following a failed horizontal butt stroke; in this case the rifle is kept in a horizontal position.
13. **Slash.** The slash can be used at the same time, but it is particularly effective following a smash that has missed or that your opponent has dodged. Bring the rifle down hard diagonally striking your opponent between the shoulder and the head.
14. **High port.** The high port position is first and foremost a defensive position used in pugil stick drills at the beginning of the combat when your adversary approaches. Nevertheless, this same position can also be used for crowd control before the first physical contact.

WARNING

The weapon must not be used as a stick to push back a crowd or contain it in a perimeter. This manoeuvre would make it possible for an assailant to seize partial or total control of the weapon.

MOVEMENTS FOLLOWING A FAILED ATTACK

15. A single movement will almost never be sufficient to kill or put your adversary out of action. In almost all cases, success will result only from a skillful combination of basic movements. The infantry soldier must always keep balanced and be ready to combine movements in order to keep the advantage of the attack.

16. **Right parry and point.** The aim of the right parry is to ward off the adversary's weapon. This movement will be followed immediately by a point to the throat or face.



Figure 15-9 Vertical Butt Stroke



Figure 15-10 Smash



15-11 Slash



Figure 15-12 High Port

17. **Left parry, butt stroke and point.** The aim of the left parry is to ward off the adversary's weapon and this movement will be followed by a horizontal butt stroke in a continuous movement. The butt stroke is directed at the opponent's head and a point is immediately directed towards a fallen or stunned enemy.

18. **Point following a failed attack.** If the adversary retreats in order to parry a point, slightly bend your left arm, move your rear foot forward and execute another point, stiffening the left arm in order to increase the force of the blow. A series of points can be executed until the adversary is struck. Execute a series of points in rapid succession in order to keep your opponent off balance.

19. **Point and vertical butt stroke.** If a point is directed at the opponent's face and the bayonet passes over the head after the enemy ducks, bend the left arm slightly, push forward off the rear foot and bring the butt of the rifle upwards in a relatively short vertical arc. Aim the butt at your opponent's groin or solar plexus.

20. **Point and horizontal butt stroke.** If a point has been executed to either side of your opponent or if it has been dodged, instead of returning on the defensive, push forward off your rear foot and bring the butt of the rifle across in a wide horizontal arc.

21. **Butt stroke and smash.** If a butt stroke misses your adversary, continue the movement until the rifle is approximately in the position shown in Figure 15-10. Then push forward off your rear foot and direct the butt of the rifle against your adversary's face or throat with as much force as possible.

22. **Smash and slash.** If your adversary backs up in order to avoid a smash, the rifle is in an excellent position to execute a slash. Push forward off your rear foot and bring the bayonet down diagonally between your opponent's neck and shoulder.

COMBINATION MOVEMENTS

23. Figures 15-13, 15-14 and 15-15 illustrate various effective ways to combine consecutive movements after a bayonet attack has failed. Several other combination movements are possible depending on the effectiveness of your opponent's reactions.

PUGIL STICK DRILL

24. Pugil stick drill is the most realistic way to teach the art of bayonet fighting. This method places the infantry soldier in the presence of an adversary who thinks, moves, retreats, dodges, reciprocates and corrects movements. The soldier must learn to remain vigilant and react instantly. A timid soldier will very quickly become tired of being beaten and will counterattack. As soon as the soldier becomes aware of the advantages of attack over defence, the soldier becomes self-confident and moves aggressively.

25. Pugil stick drill is also an excellent way to improve physical fitness. The soldier must make a maximum effort during bouts that usually last 45 seconds to one minute and 30 seconds. Several factors are required in order to obtain full benefit from the exercise involved in this combat technique: training received, protective equipment, instruction, supervision and safety.

26. **Training received.** It is very important for each soldier to be fully trained before participating in pugil stick bouts. A lack of technique and knowledge will make a soldier ineffective and increase the risk of sustaining injuries.



Figure 15-13 (Page 1 of 3) Point, Horizontal Butt Stroke, Smash, Slash, Point



Figure 15-13 (Page 2 of 3) Point Horizontal Butt Stroke Smash Slash Point



Figure 15-13 (Page 2 of 3) Point Horizontal Butt Stroke Smash Slash Point



Figure 15-13 (Page 3 of 3) Point Horizontal Butt Stroke, Smash, Slash, Point



Figure 15-13 (Page 3 of 3) Point Horizontal Butt Stroke, Smash, Slash, Point



Figure 15-14 (Page 1 of 2) Left Parry, Horizontal Butt Stroke, Slash, Point



Figure 15-14 (Page 1 of 2) Left Parry, Horizontal Butt Stroke, Slash, Point



Figure 15-14 (Page 2 of 2) Left Par Horizontal Butt Stroke Slash Point



Figure 15-14 (Page 2 of 2) Left Par Horizontal Butt Stroke Slash Point



Figure 15-15 (Page 1 of 2) Point, Vertical Butt Stroke, Smash, Point



Figure 15-15 (Page 1 of 2) Point, Vertical Butt Stroke, Smash, Point



Figure 15-15 (Page 1 of 2) Point, Vertical Butt Stroke, Smash, Point

27. **Protective equipment.** All the equipment must be well adjusted and in good condition. This equipment comprises the following:

- a. **Helmet.** The helmet must be adjustable so that it can fit the head. It must not rock back and forth or obstruct the view of a soldier who has been struck on the top of the head, nor must it pivot when the soldier is struck on the side of the head. If the helmet is slightly too big, fill the empty space with foam rubber padding;
- b. **Protective mask.** The protective mask must be fastened firmly and the lower bar must be padded where it rests on the chest or strikes it;
- c. **Groin protector.** The groin protector belt must be in good condition and must hold the protector firmly against the body;
- d. **Gloves.** The gloves must be padded and in good condition; and
- e. **Pugil stick.** The pugil stick must be in good condition and well padded. Do not use broken or cracked sticks.

28. Details concerning the equipment shown below as well as its specific characteristics and the method of manufacturing the pugil stick are found at Annex B of this chapter.

29. **Instructions.** The instructor's directives are the most important factor in preventing accidents. The instructor must insist on the soldiers executing bayonet fighting movements. Erratic windmill styles will not be tolerated. The soldiers must always keep both hands on the pugil stick.

30. **Supervision and safety.** The instructor must be attentive to the slightest risk of injury and stop the bout by blowing a whistle. Persons who have suffered from hernia, frequent headaches, concussions, or those who have recently had teeth extracted, or have stitches in place must be excluded from the pugil stick drill as a precautionary measure until advised otherwise by the doctor.

CONDUCT OF TRAINING

31. The soldiers must begin by learning and then practising, with the service rifle, the basic movements and movements to use when a blow has failed to land (Lessons 1 and 2 at Annex A). Then they will be outfitted with the pugil stick equipment, and will practise the basic movements and movements to use when a blow has failed to land against an adversary who is making only defensive movements (Lesson 3 at Annex A). The next phase consists of competitive bouts with the pugil stick. When the soldiers have mastered the technique and shown an aggressive spirit, they will be taught group attack tactics (Lessons 4, 5 and 6 at Annex A). The teaching program should not comprise more than one bayonet or pugil stick drill per day, because of the resulting fatigue.

COMBAT

32. **Organization.** At the beginning of the pugil stick drill, it is advantageous to work with groups not larger than a platoon. Trace a circle with a diameter of about 12 paces on the ground. This becomes the arena. The soldiers stand around the outside of the circle and the instructor, who acts as a referee, remains in the circle.

33. **Bout.** The instructor announces the beginning of the bout by blowing a whistle and designating two soldiers. They advance into the arena with their weapons held high and begin the bout. In the first bout, the adversaries may exchange blows in order to realize that their protective equipment will protect them sufficiently well against a hard blow. The instructor will then direct the bouts in a closed area.

34. **Bout in a closed area.** A bout in a closed area comprises three one-minute rounds. The winner of the bout is the one who "kills" the opponent by putting the opponent out of action or causing the opponent to leave the arena. A "kill" consists in striking the adversary with a blow that would have killed or put an enemy soldiers out of action if a rifle was used. The bout can be stopped with a whistle when one of the adversaries wins or the minute is up. The adversaries withdraw to opposite sides of the arena and when the whistle is blown again, the combat resumes. The soldier who wins two of three rounds wins the bout. Another method consists in organizing bouts with a single round lasting three minutes.

35. **Instructor.** It is recommended that the instructor also be dressed in protective gear. If feelings begin to run high and the adversaries fail to stop at the sound of the whistle, the referee will intervene immediately and stop the bout. The referee must be constantly vigilant to detect any danger, including any equipment breakage and if necessary stop the bout immediately. The instructor will insist on combatants shouting during the bout. This fosters aggressiveness and enables them to keep their mouths open so that they will not break their teeth because of a blow on the head. They must be encouraged to be aggressive and attack rather than waiting for their adversary. If a soldier executes a movement poorly or completely loses balance, the instructor will stop the bout, correct the problem and then allow the bout to continue.

LESSON GUIDE

LESSON 1 - BASIC BAYONET MOVEMENTS

1. **Aim of the lesson.** To teach soldiers to perform basic bayonet movements.
 - a. on guard, rest and high port;
 - b. point and extraction of weapon;
 - c. vertical and horizontal butt strokes;
 - d. smash;
 - e. slash; and
 - f. right and left parry.
2. **Duration.** Fifty minutes are required to complete Lesson 1.
3. **Training equipment and supplies.** A rifle equipped with a bayonet for each soldier.
4. **Program and method.**
 - a. **Safety measures.**
 - b. **Introduction.** Review very briefly the role of the rifle. Explain the aim and principles of bayonet fighting. Insist on the fact that this weapon still belongs on today's battlefield.
 - c. **Training.**
 - (1) Demonstrate, explain and demonstrate again, having the soldiers imitate the movements. The soldiers must then practise each basic movement in the order in which they are given in para 1. The soldiers will stand in line, leaving enough space between them to execute lateral movements.
 - (2) During the drill, use the commands indicated in para 1. This training will be fairly tiring for the soldiers and they must react instantly to the orders given. Each soldier will be required to participate energetically.
 - d. **Conclusion.** Tell the soldiers that, in the following lesson, the basic attacking movements will be combined in various manners.

LESSON 2 - MOVEMENTS FOLLOWING A FAILED ATTACK

1. **Aim of the lesson.** The aim of the lesson is to teach the soldiers to execute basic movements to be used to continue the attack when a blow has failed to land.
2. **Duration.** Fifty minutes are required to complete Lesson 2.
3. **Training equipment and supplies.** Obtain the following:
 - a. a rifle equipped with a bayonet for each soldier, and
 - b. training dummies (preferably with parry arms).
4. **Program and method.**
 - a. **Safety precautions.**
 - b. **Review.** Repeat the basic movements taught in Lesson 1.
 - c. **Introduction.** Explain that no one basic movement can kill or put an enemy out of action. A combination of movements is required. Explain to the soldiers that they must use common sense and modify the combination movements taught during this lesson.
 - d. **Training.**
 - (1) Demonstrate, explain, demonstrate again and have the soldiers practise each of the combinations outlined below. Use the terms for the movements when giving orders during the drill.
 - (2) Have the soldiers stand about two metres apart in a straight line.
 - (3) Have them execute combination movements in the following order:
 - (a) point, extraction;
 - (b) point, point, extraction;
 - (c) right parry, point, extraction;
 - (d) left parry, butt stroke, point, extraction;
 - (e) left parry butt stroke, slash, point, extraction;
 - (f) point, vertical butt stroke, point, extraction; and

(g) left parry, butt stroke, smash, slash, point, extraction.

e. **Drill with Dummy.**

- (1) Demonstrate, explain, demonstrate again and have the soldiers carry out each of the combination movements indicated above, using dummies.
- (2) Insist on the vigour and aggressiveness of attacks, which will be accompanied by grunts and shouts.
- (3) After the initial drills in which the soldiers will execute the orders, have them attack the dummy, using complete combinations of movements.

f. **Conclusion.** Tell the soldiers that the basic and combined movements that they have learned will be applied against their adversaries.

LESSON 3 - INTRODUCTION TO PUGIL STICK DRILL

1. **Aim of the lesson.** The aim of the lesson is to teach the soldiers to execute the basic movements and movements following a failed attack, using pugil stick drill equipment.

2. **Duration.** Fifty minutes are required to complete Lesson 3.

3. **Training equipment and materials.**

a. Each soldier must have:

- (1) a pugil stick,
- (2) a pair of lacrosse or hockey gloves,
- (3) a groin protector, and
- (4) a football helmet with a protective mask and chin guard strap.

b. Each instructor must have:

- (1) a helmet, gloves and groin protector, and
- (2) a whistle.

4. **Distribution and adjustment of equipment.** Pugil stick drill equipment will be handed out to the soldiers and adjusted before the beginning of this lesson. An instructor will need about 30 minutes to adjust the equipment of 20 to 30 men. The following points should be noted:

- a. **Helmet.** The helmet must be perfectly adjusted on the head to be effective. It must remain in place despite a hard blow on the top or side. The chin guard strap can be adjusted to a comfortable fit. Foam rubber padding can be added inside the helmet, if necessary. Ensure that a hard blow to the protective helmet will not move the helmet or push the mask into the soldier's face. When the adjustments have been completed, the soldier's name can be fastened to the helmet with adhesive tape to accelerate the distribution of the equipment during subsequent lessons.
- b. **Gloves.** The gloves must be comfortable.
- c. **Groin protector.** The groin protector is worn over the clothing. Ensure that the belt is in good condition and that the cup is adjusted comfortably.
- d. **Pugil stick.** The pugil sticks are not adjusted, but must always be examined before they are distributed. Do not use broken or cracked sticks. If the seams on the canvas covering are loose, the stick must NOT be used.

5. **Program and Method.**

- a. **Introduction.** Briefly summarize the reasons for the pugil stick drill. Warn the soldiers that kicking or kneeing, etc, will not be used during the pugil stick drill although they will be in combat.
- b. **Organization.** Form two-man teams and have them line up facing each other at from four to five metres apart. Designate one of the members as the attacker and the other as the defender. Have all the attackers on the same side.
- c. **Procedure.**
 - (1) The attackers will advance on the defenders with the defenders using only defensive movements, parrying and blocking attacks with their sticks and backing up. Have the attackers use the combination movements described in para 4d(3) of Lesson 2 until they are thoroughly familiar with them and then reverse the roles.
 - (2) In the next stage, have the attackers execute all the combination movements while trying to land hard blows. The defenders will protect themselves with their sticks while backing up. Reverse roles.
- d. **Conclusion.** Explain to the soldiers that, after mastering the combination movements with pugil stick drill equipment, they will engage in actual bouts in which they will not be limited to either attacking or defensive roles.

LESSONS 4, 5 AND 6 - PUGIL STICK DRILL

1. **Aim of the lessons.** The aim of the lessons is to have the participants take part in pugil stick drills, making correct use of bayonet handling movements.
2. **Duration.** Fifty minutes are required to complete each lesson.
3. **Training equipment and materials.** The following items are required:
 - a. a complete set of pugil stick drill equipment for each soldier,
 - b. a complete set of protective equipment for each instructor; and
 - c. a whistle.
4. **Program and Method.**
 - a. **Equipment.** Distribute and inspect the equipment and check the adjustment.
 - b. **Review.** Briefly review the combination movements in Lesson 3 (omit this phase for Lessons 5 and 6).
 - c. **Introduction.** Explain the organization and conduct of pugil stick bouts. Insist on the soldiers' attacking when they hear the whistle and stopping when they hear it again.
 - d. **Procedure.** Direct the pugil stick bouts. One instructor must referee each of the bouts. The instructor will remain vigilant to detect any hazardous situation and will stop the bout when:
 - (1) equipment becomes loose or breaks,
 - (2) a "lethal" blow has been landed,
 - (3) a soldier executes a movement poorly (correct it and restart the bout), or
 - (4) the time has expired.
 - e. **Conclusion.** Review the lessons and emphasize the importance of aggressiveness and quickness.
5. **Additional drill.** Once the six lessons have been completed, the soldiers must participate regularly in pugil stick drills to retain their skills. Since pugil stick drills are an excellent way to improve a soldier's physical fitness, the drills could be put to good use in the unit's physical training program.

PUGIL STICK DRILL EQUIPMENT

GENERAL

1. The protective equipment should enable a soldier to participate in the bouts without fear of being injured. This will help the soldier to develop a personal bayonet fighting style and improve skills. The parts of the body to protect are the head, face, groin and hands. The equipment described below is designed to protect against injury (see Figure 15B-1).

2. The equipment designed to protect the head is a football helmet with a stainless steel mask.

a. **Football helmet.** When purchasing football helmets, take various possible head sizes into account. It is recommended that 10 percent of the helmets be size 6-1/2 to 6-3/4, 80 percent size 6-7/8 and 10 percent size 7-1/4 to 7-1/2. Helmets that are too big can be adjusted by adding foam rubber padding inside them. A vinyl plastic chin guard strap and foam rubber are used to attach the helmet.

b. **Characteristics of Protective Mask.**

- (1) The protective mask is made of 0.635-cm (1/4-inch) stainless steel bars that have been electric-arc-welded at all junction and intersection points. The mask must consist of a rear shell and a lower shell which are attached to three vertical bars and two horizontal ones.
- (2) The mask is manufactured in accordance with the specifications set out in Figures 15B-2 and 15B-3. A vertical bar is attached at 5.72 cm (2-1/4 inches) on each side of the central bar.
- (3) Two horizontal bars are used to reinforce the vertical bars. The upper bar is connected to each side of the rear shell at the points where this shell curves as well as on the lower parts of the vertical bars. The lower horizontal bar extends from one vertical lateral bar to the other, going under the central vertical one. This bar is fastened 2.54 cm (1 inch) above the base formed by the lower shell.

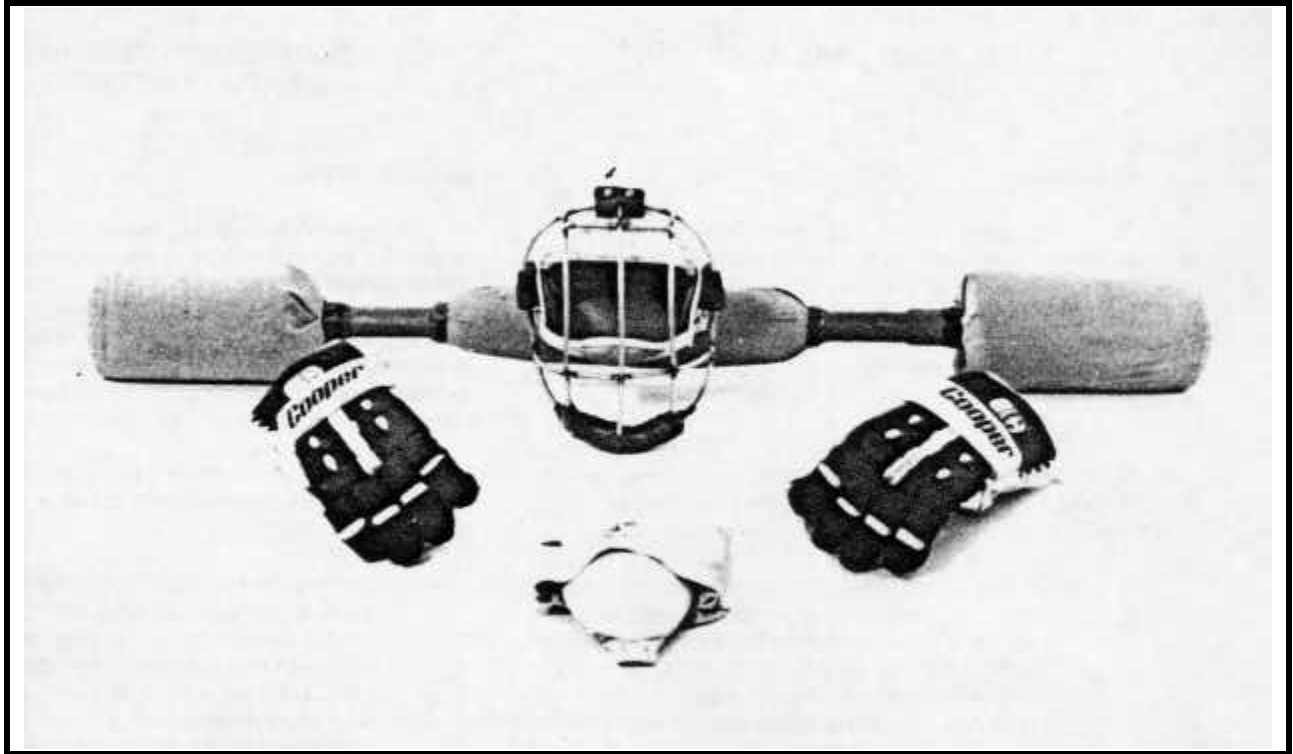

Figure 15B-1 Pugil Stick Drill Equipment

- (4) The convex part of the mask is formed as follows:
 - (a) the contour of the rear shell that curves downwards towards the ears. This curve has a radius of 9.53 cm (3-3/4 inches), measured from a point located 5.4 cm (2-1/8 inches) above the base line formed by the lower shell,
 - (b) the form of the upper horizontal bar, whose 9.53 cm (3-3/4 inch) radius is measured from a point located 3.2 cm (1-1/4 inches) in front of the base line, and
- (5) The curve of the central vertical bar has a radius of 17.15 cm (6-3/4 inches) measured from a point located 4.4 cm (1-3/4 inches) in front of the vertical base line and 1.27 cm (1/2 inch) below the horizontal line. The curve of the two lateral vertical bars has a radius of 16.5 cm (6-1/2 inches), measured from a point located 3.2 cm (1-1/4 inches) in front of the vertical base line and 3.2 cm (1-1/4 inches) below the horizontal base line.
- (6) The drawings in Figures 15B-2 and 15B-3 give additional measurements.

c. **Fastening the Protective Mask to the Helmet.**

- (1) The protective mask is fastened in front of the helmet at three points: centre, right side and left side (Figure 15B-3).
- (2) It must be fastened with a strap of industrial leather 5 cm (2 inches) wide and 0.49 cm (3/16 inches) thick, with the outside polished. The leather strap must be wrapped around the bar and its two ends must be firmly attached to the helmet.
- (3) The central leather strap must be 5 cm (2 inches) wide and 8.26 cm (3-1/4 inches) long. A hole 1.91 cm (3/4 inch) in diameter is made in the centre of the leather strap. A 1.12 cm (7/16 inch) wide slit is cut from one end of the strap to the central hole. Four additional holes 0.32 cm (1/8 inch) in diameter are made, two on each end of the strap 1.27 cm (1/2 inch) from the sides and 1.91 cm (3/4 inch) from the ends.
- (4) The lateral leather straps are identical and are 5 cm (2 inches) wide and 7.63 cm (3 inches) long. Two 0.32 cm (1/8 inch) holes are made on each side of the strap 1.27 cm (1/2 inch) from the sides and 1.12 cm (7/16 inch) from the ends.
- (5) The mask is connected to the centre of the helmet by drilling two holes to attach the leather strap. The split end of this strap is placed on the central bar of the mask and under the rear shell. The other end of the strap is then folded so that the holes of the two ends coincide with the holes in the helmet. It is then attached by two split, copper rivets, with a diameter of 10 and 1.6 cm (5/8 inch) long and by riveting burrs. Any other rust-resistant, self-locking fastener may be used, provided that it has a smooth surface on the inside and outside of the helmet, and that it has the same dimensions and resistance as the recommended copper rivet. The rivet passes through the helmet and the two ends of the strap.

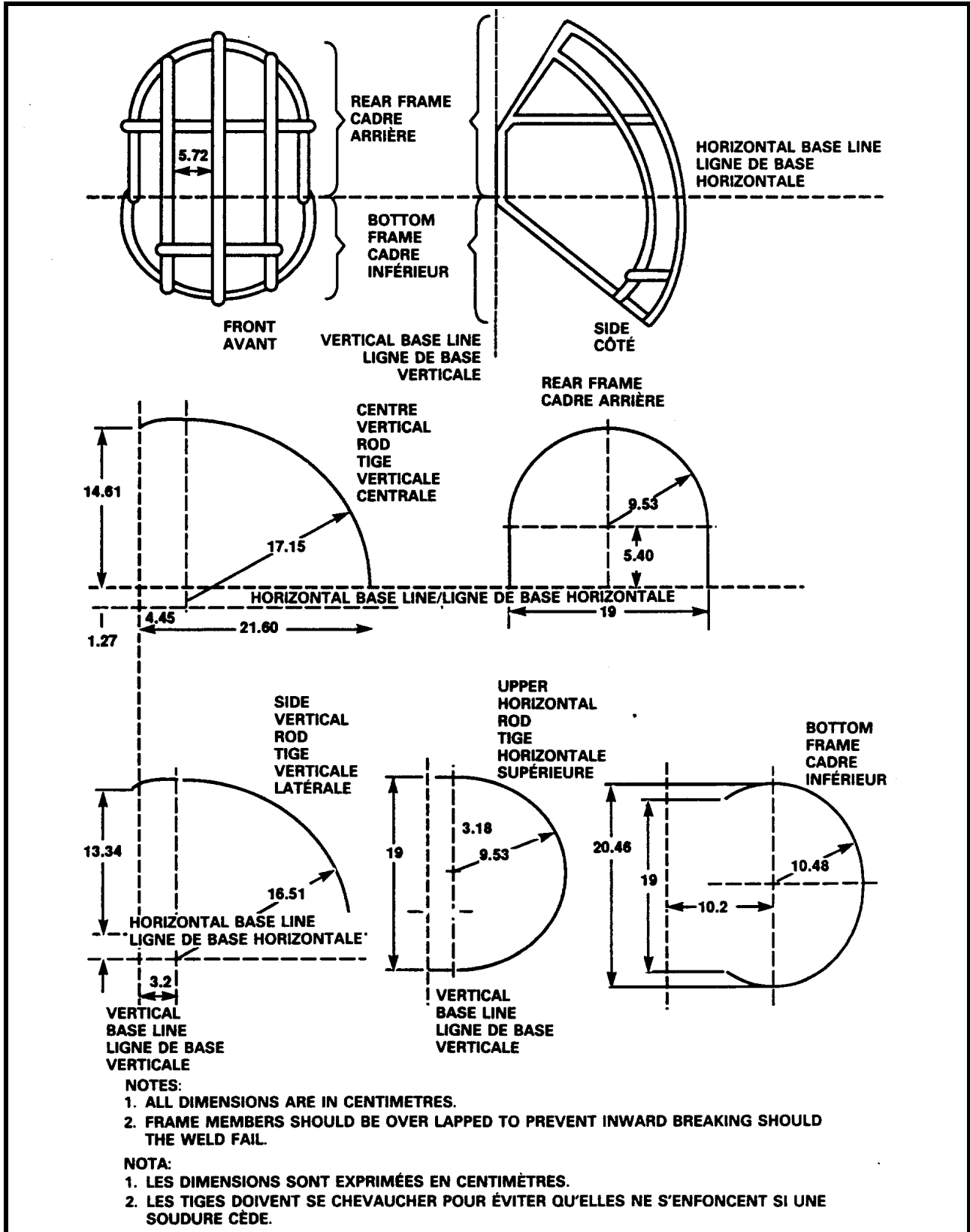

Figure 15B-2 Characteristics of Protective Mask

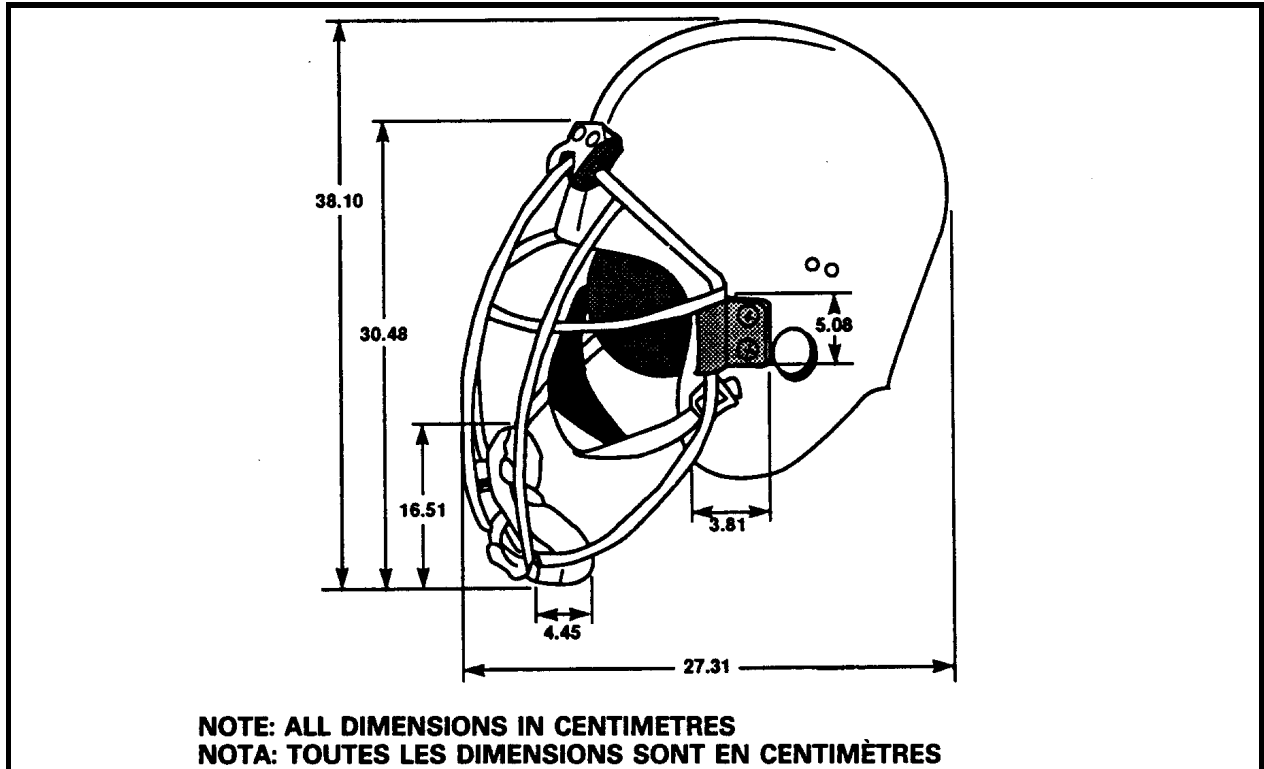

Figure 15B-3 Protective Helmet and Mask

- (6) The mask is attached on each side of the helmet to the section of the rear shell that is parallel to the front edge of the part of the helmet that protects the ears. The type of fastener makes it possible for the mask to move somewhat when it is struck. The fastener covers a 6.35 cm (2-1/2 inches) section of the rear shell, leaving a 1.27 cm (1/2 inch) portion of the bar uncovered when it is in position. This fastener is attached in such a way that the upper joint of this section or the bar (the junction of the rear shell and the upper horizontal bar) rests on the upper edge of the fastener, leaving a vertical play of 1.27 cm (1/2 inch). The lateral fasteners are attached in the same manner as the central ones, using the straps described in 2c(5).
- d. **Characteristics of the mask cushion.** The lower part of the mask must have a moulded foam rubber cushion 16.512 cm (6-1/2 inches) long, 4.45 cm (1-3/4 inches) wide and 1.91 cm (3/4 inch) thick. The cushion will have two heavy canvas straps 1.27 cm (1/2 inch) wide, each of which has a metal snap fastener making it possible to fasten it to the lower shell of the mask. This cushion protects the upper part of the chest when the mask is driven in by a hard blow.

GROIN PROTECTION

3. The groin is protected by a canvas apron fitted with a cup similar to those found in athletic supporters. It is worn over the clothing so that it can be put and taken off quickly on the training field. This apron should be made of drill. Recycled half-tents and platoon tents can be used as long as the canvas is still in good shape.

HAND PROTECTION

4. Lacross gloves are recommended for pugil stick drill. They provide maximum protection for the fingers, knuckles and wrists and make it possible to move the stick effectively. Hockey gloves can also be used but they slightly restrict movement.

PUGIL STICK

5. **Materials.** The list of material required to make the pugil stick is found in Figure 15B-4. To provide better protection, the stick handle can be covered with foam rubber, leaving enough room for the hands. Light sticks can be made heavier by rolling rubber from automobile inner tubes around the central part of the handle under the layer of foam rubber.

6. **Construction.** The steps in making a pugil stick are mentioned below and Steps 1 to 6 are illustrated in Figure 15B-5:

- a. **Step 1.** Cut a stick with the required dimensions.
- b. **Step 2.** Spread a sheet of plastic foam 1.27 cm (1/2 inch) thick, 12.7 cm (5 inches) wide and 1.22 m (4 feet) long on a flat surface and roll it as tightly as possible. Roll two of these sheet and place them at each end of the stick. Apply rubber cement on the contact surface as the sheet is rolled on.
- c. **Step 3.** To prepare the end of the stick representing the bayonet, spread a sheet of plastic foam 1.27 cm (1/2 inch) thick, 29.21 cm (11-1/2 inches) wide and 3.66 m (12 feet) long on a flat surface. Apply rubber cement on the contact surface and roll it as tightly as possible around the pods formed by the small roll of plastic foam covering the stick, which was made in Step 2. Attach the roll with elastic bands. Let dry for at least 24 hours.
- d. **Step 4.** To make the part of the stick that represents the rifle butt, cut a sheet of plastic foam of decreasing width in accordance with the dimensions indicated in Figure 15B-5, and proceed as indicated in Step 3.
- e. **Step 5.** Make two canvas bags 15.2 cm (6 inches) in diameter and 35.6 cm (14 inches) long. Use the French stitching illustrated in Figure 15B-5 to reinforce the seams.

- f. **Step 6.** Place the canvas bag on the end of an adjustable sleeve such as a piece of sheet metal of No. 28 thickness. At the other end, insert the end of the stick covered with plastic foam. Exert sufficient pressure on the body of the metal sleeve; push the stick into the canvas bag and withdraw the metal sleeve.
- g. **Step 7.** Attach the canvas bag to the stick with No. 4 fencing staples and then cut off the surplus canvas.
- h. **Step 8.** Cover the No. 4 fencing staples with strips of heavy cardboard.
- j. **Step 9.** Cover the cardboard strips with adhesive tape.

OBTAINING PUGIL STICK DRILL EQUIPMENT

7. The training aids personnel can make pugil sticks and groin-protector aprons on the site. The helmet and mask, gloves and the cup used to protect the groin are items found in commercial stores and are not kept in stock. Out-of-sequence serial numbers are used to identify these items and they are purchased locally. To obtain appropriate equipment that is consistent with safety and protection standards, the supplier or contractor must know the specifications set out in this document. It must be noted that the mask is attached to the helmet so that it will move slightly under the effect of a blow. This automatically eliminates a part of the shock that would otherwise be completely transferred to the head and neck, if the mask were solidly attached to the helmet.

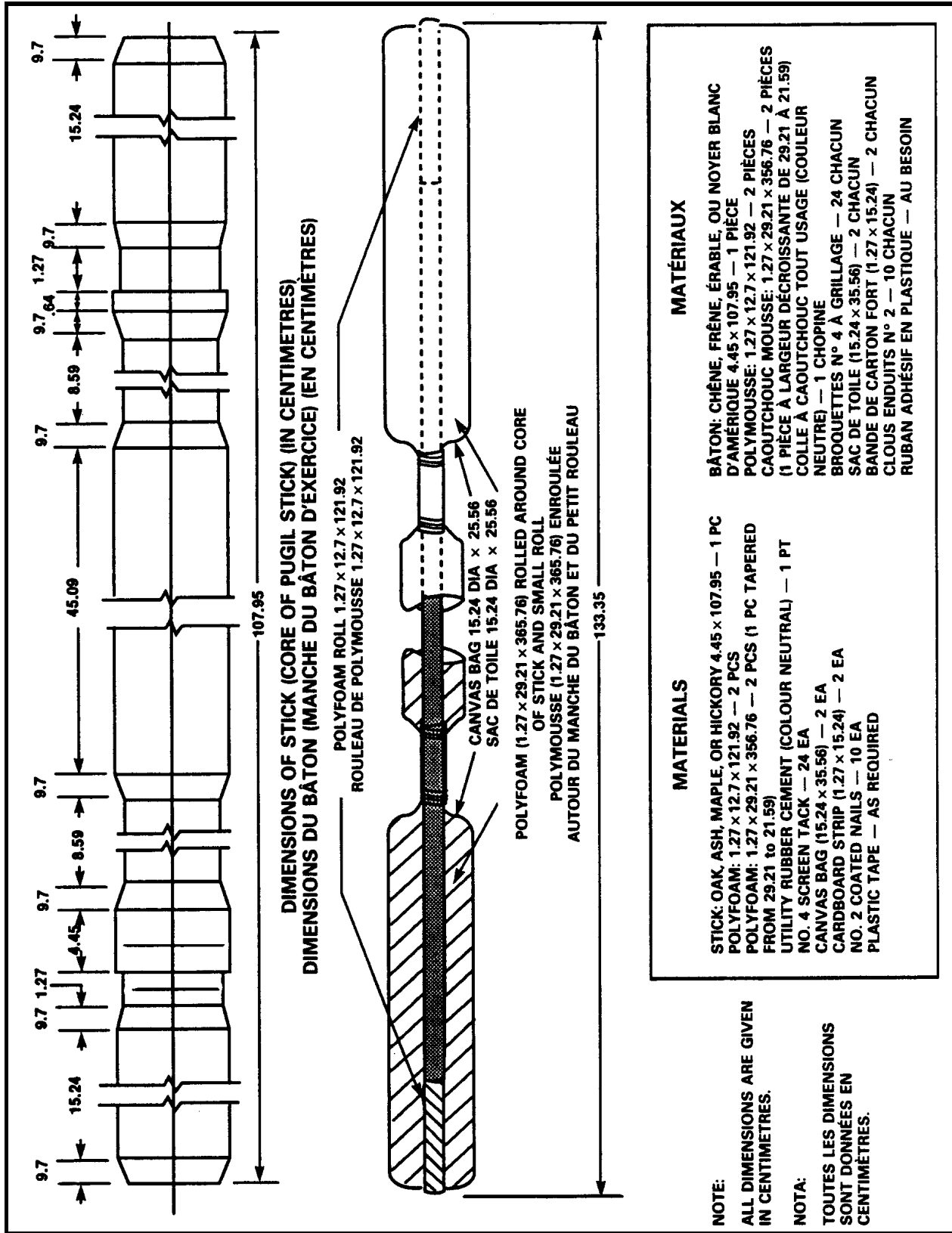

Figure 15B-4 Materials Required to Make a Pugil Stick

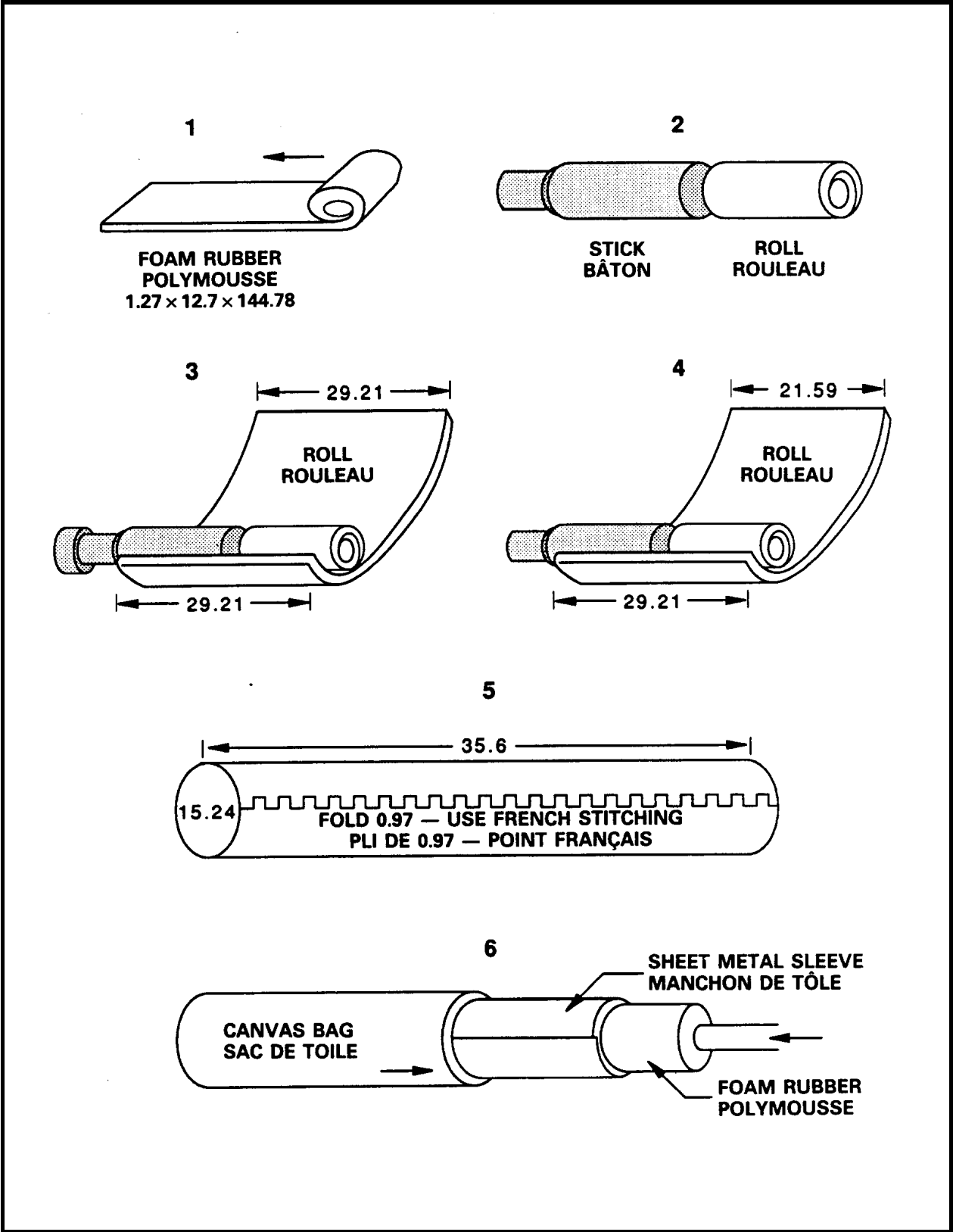

Figure 15B-5 Steps in Making a Pugil Stick

BAYONET FIGHTING TRAINING APPARATUS

GENERAL

1. To ensure that soldiers can properly execute the movements used in bayonet fighting, they must have a suitable target on which to practise.
2. The use of a properly constructed target will minimize the damage to either the weapon or bayonet. However, the zeroing of the weapon will always be affected.

SACKS

3. The sacks are constructed of tent canvas tightly packed with styrofoam chips, straw or some similar material.
4. The sacks may be patched with a tent repair kit and should be regularly restuffed.

THE MANNEQUIN

5. The mannequin is used to practise the point and smash.
6. The mannequin (see Figure 15C-1), may be designed so that it can be used on a drill hall floor, parade square or any other temporary site. The installation of the mannequin on a permanent area, where it is possible to place the legs of the stand into the ground, will result in a large saving in lumber. However, any outdoor stand should be frequently treated with wood preservative and the sacks should be stored indoors when not in use.

GROUND SACK

7. The ground sack is used to practise the ground point and extraction (see Figure 15C-2).
8. For indoor training, the ground sack should be backed by a 30 cm thick styrofoam block, a 30 cm thick foam rubber block or any material that will protect the bayonet from being broken on the floor.

THE SCAFFOLD

9. The scaffold is used to practice the parry, butt stroke and slash.
10. The scaffold (see Figure 15C-3) can be de-signed for use either indoors or outdoors.

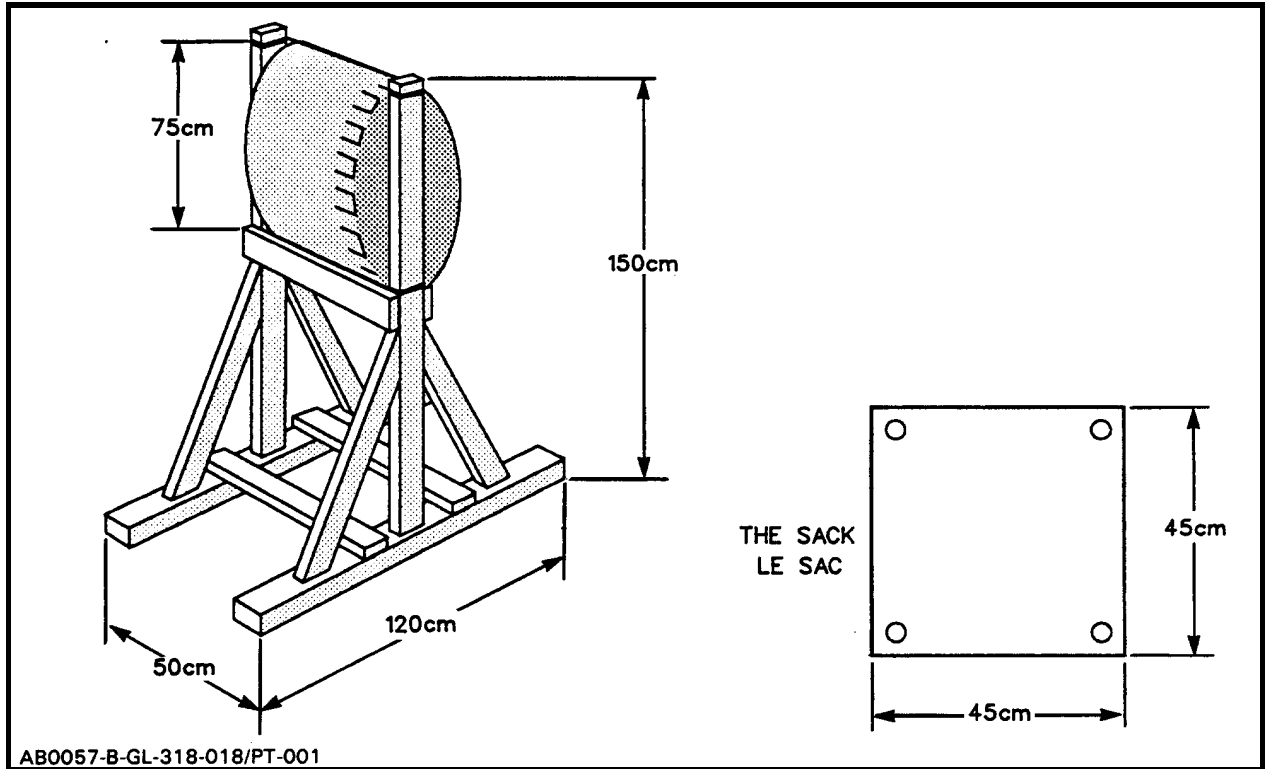

Figure 15C-1 The Mannequin

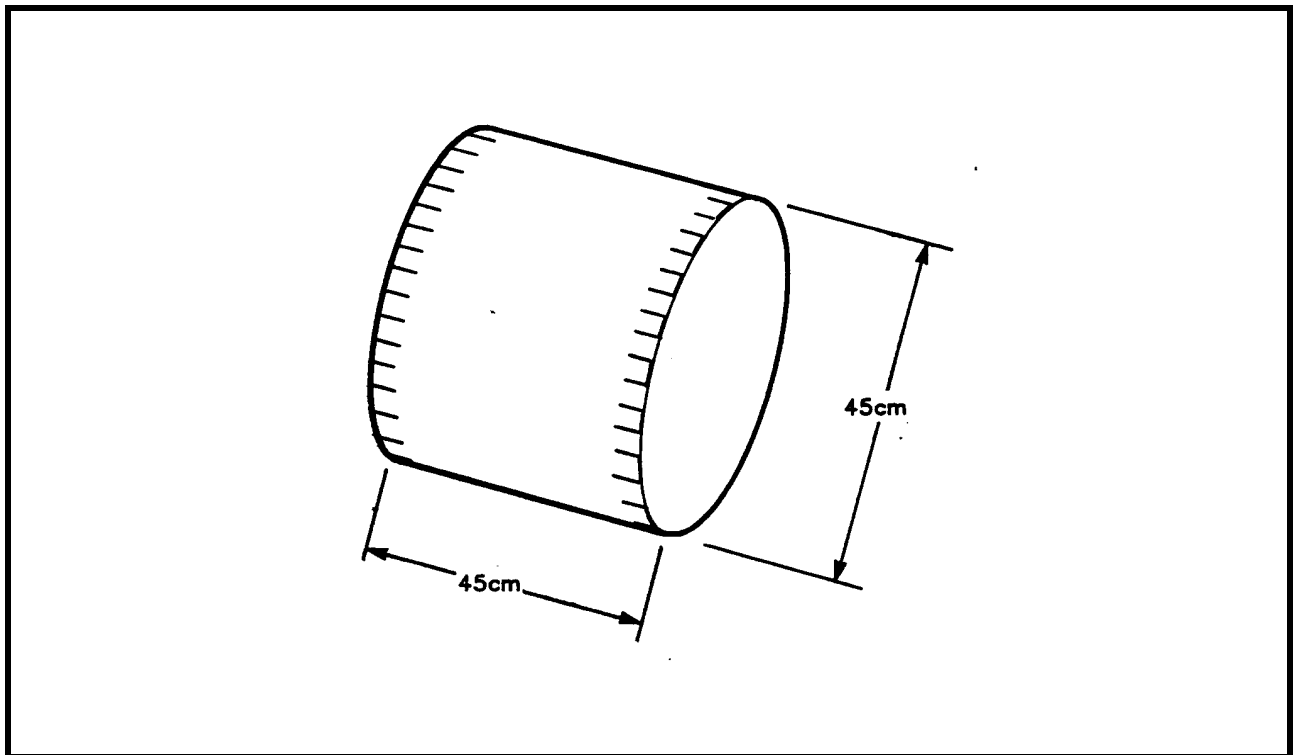

Figure 15C-2 The Ground Sack

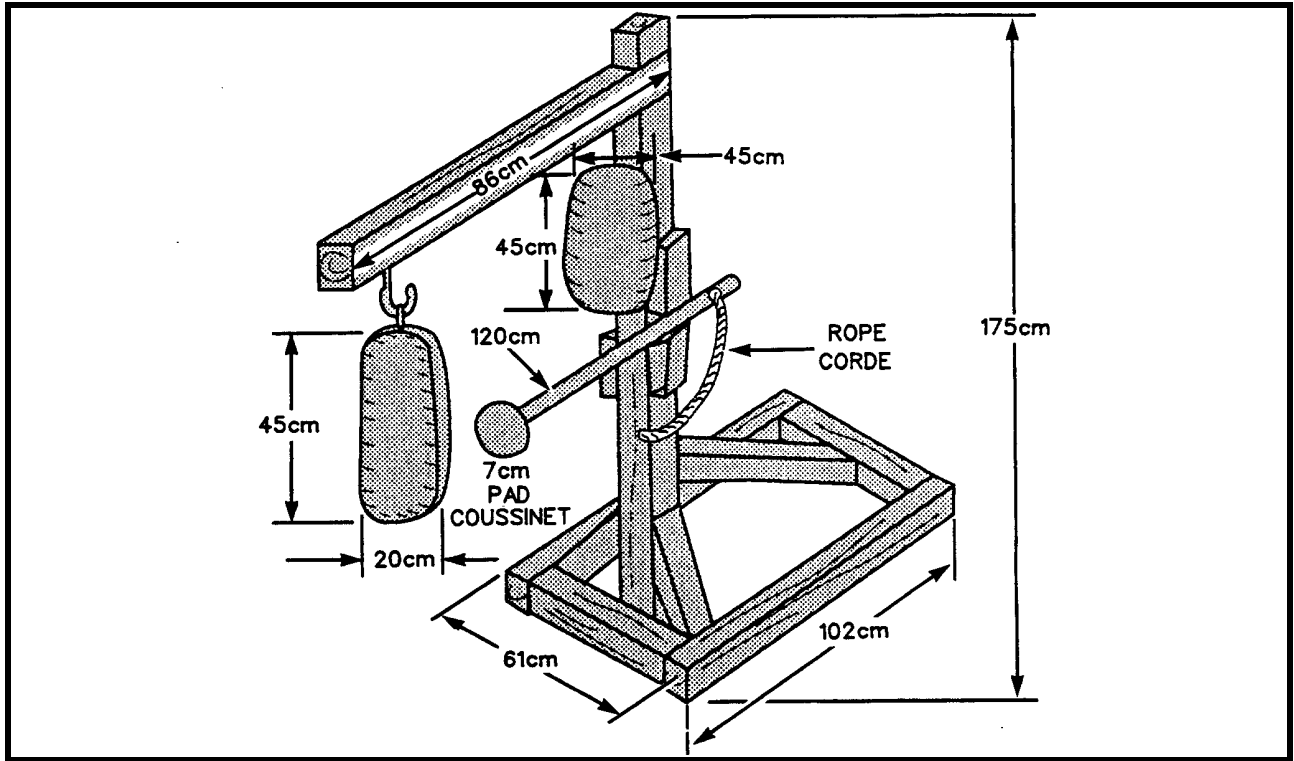

Figure 15C The Scaffold

CHAPTER 16

VULNERABLE POINTS OF BODY

GENERAL

1. Vulnerable points are areas of the body which are particularly susceptible to blows or pressure. Since your life is at stake, you should forget any concept of fair play, and attack these vulnerable points. Striking your opponent in a vulnerable area may cause him to drop his defence temporarily, thus leaving him open to receive your follow-up blows to other parts of his body. The important vulnerable point of the body are discussed below.

VULNERABLE POINTS IN THE HEAD AND NECK REGION

2. **Eyes.** Blows to the eyes will cause temporary or permanent blindness and intense pain.
3. **Nose.** Blows to the nose cause intense pain and watering of the eyes.
4. **Ears.** Sharp, heavy blows can cause brain concussion. Lesser blows can cause shock or result in ruptured eardrums and internal bleeding.
5. **Nape of the Neck.** A blow to the nape of the neck may cause temporary loss of consciousness. If you strike with great force you can break his spine.
6. **Adam's Apple.** A blow to the Adam's apple usually causes pain and breathlessness. If such a blow is delivered forcefully, the Adam's apple may be crushed and the opponent will strangle.
7. **Temple.** Forceful hand blows to the temple may cause loss of consciousness and could result in death.

VULNERABLE POINTS OF THE TRUNK

8. **Collarbone.** A broken collarbone will cause intense pain and will disable the attached arm.
9. **Solar Plexus.** A sharp blow to the solar plexus will cause shock, breathlessness, and possible internal injuries.
10. **Stomach.** A sharp blow to the stomach also will cause breathlessness and possible internal injuries.
11. **Kidneys.** Forceful blows to the kidneys will cause intense pain, shock and internal injuries.

12. **Spine.** Vigorous blows can dislocate the vertebrae of the spine, pinching and severing the spinal cord, and causing intense pain or paralysis.

13. **Groin.** The groin is a very accessible target. Striking the groin will cause extreme pain and disability.

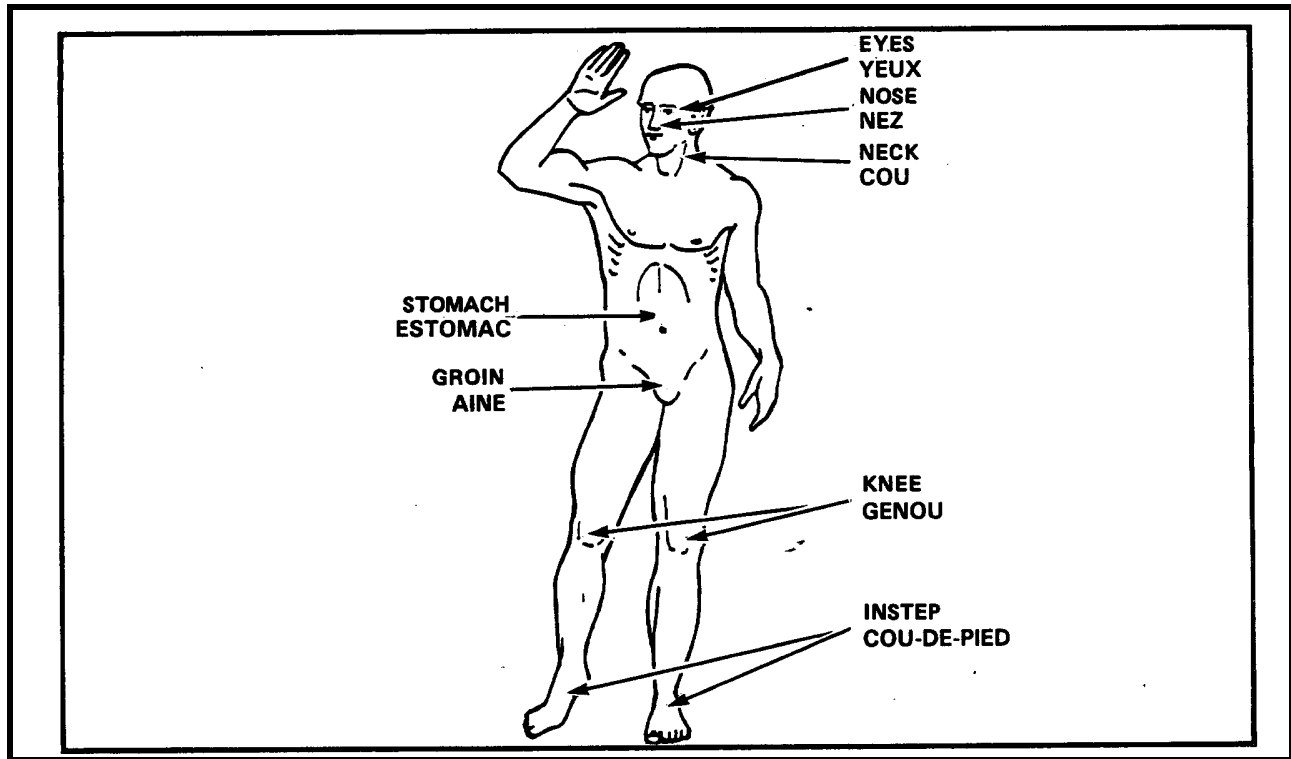

Figure 16-1 Vulnerable Points of the Body

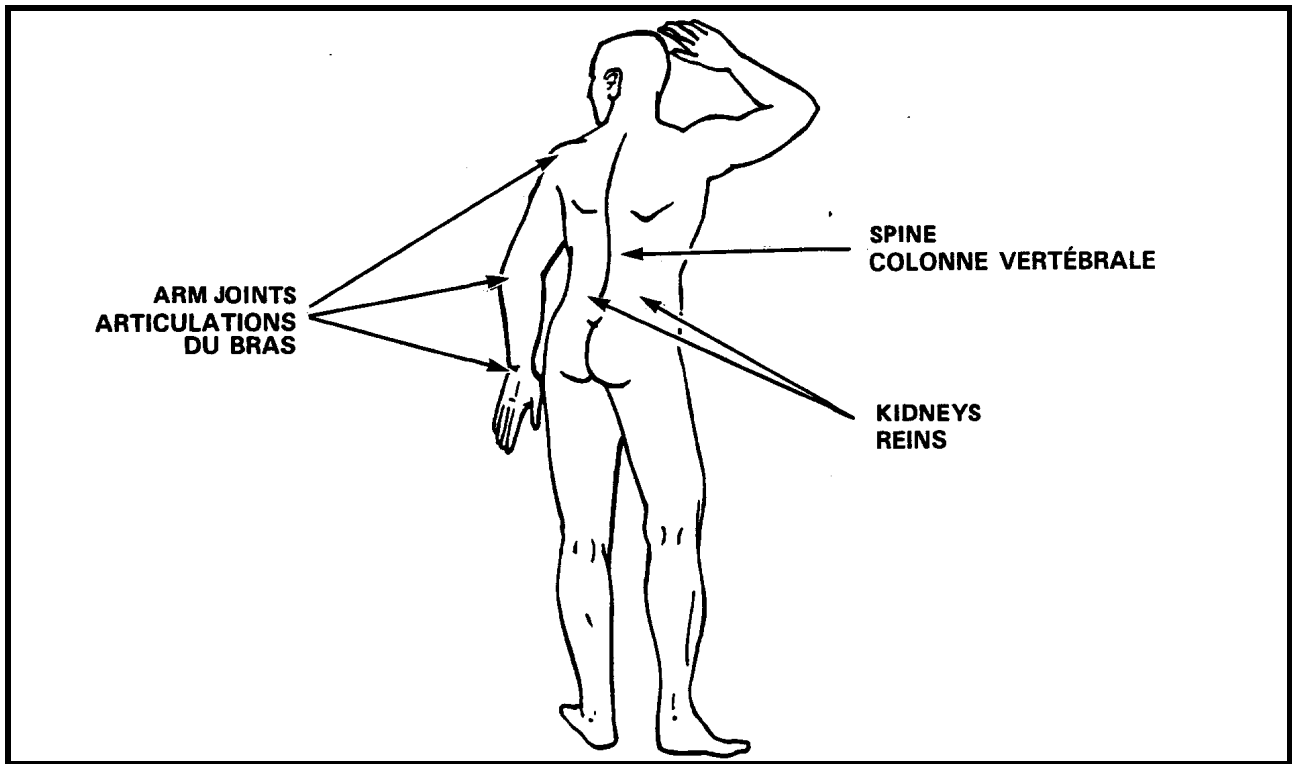

Figure 16-2 Vulnerable Points

VULNERABLE POINTS OF THE LIMBS

14. Blows to the limbs will cause intense pain and disability.
15. **Arms.** Using blows, it is difficult to disable the arms of a standing opponent. The bones of his arms and hands can be broken by using certain procedures discussed earlier in this manual.
16. **Legs.** A kick to the shin is very painful. The small bones of the ankle and foot can be broken, crippling our opponent. The knee bends in only one direction, and its tendons and cartilage can be torn by kicks to the side or front of the knee.

ANNEX A

NOTES TO INSTRUCTORS

1. **The instructor.** The instructor must be in good physical shape, must be able to perform all of the techniques in this manual, and must possess the leadership qualities necessary to inspire his students.

CAUTION

Instructors must teach the techniques in this manual rather than their own individual styles. The techniques in this manual form the basic techniques from which most hand to hand fighting had developed, and once the student has mastered these, he can then develop very sophisticated styles. Approximately one instructor/assistant instructor for 10 student pairs (20 students) is an adequate ratio.

2. **Levels of Training -**

a. **Basic Level Unarmed Combat -**

- (1) The Basic Level is designed to teach the soldier the fundamentals of correct attacking and counter-attacking techniques. Instructors will include hand strikes, feet strikes, blocks, stances, alignments, and moving techniques.
- (2) This level of training is designed to be taught at the Battle school. In addition these skills will be maintained throughout the year during unit - run continuation training. It is recommended that 3 x 1 hour periods be devoted weekly not to run successively, but altered every day with the usual exercises of the PT programme. A unit can however, dedicate a fixed period of time such as one week bi-yearly or two days monthly with a limited loss in standard.

b. **Instructors' Level.** The Instructors' Level is a course of 10 training days where the potential instructor reinforces his Basic Level, and learns additional techniques. He develops the speed and confidence to become an effective fighter and instructor.

3. **Major Points of Unarmed Training -**

a. Always use the principles and techniques outlined in this manual. Most beginning students want to advance more quickly to the more exciting sparring sessions. However, instructors must build a firm foundation in the basic techniques first, or

progress will eventually be hampered and individual skill will never be developed to full potential. The basic techniques are the most effective killing techniques.

- b. The more you practice, the better you will get. Try to practice on your own or with a partner daily.
- c. When an opponent is in a vulnerable position, press the attack to the finish. You are learning a killing skill, not a sport, and you don't give the other person the chance to recover.

4. **Training Areas.** Any area with sufficient space (approximately eight square feet per pair of students) is suitable for use in training the techniques in this manual. A grassy open field is preferable; however, training may be conducted indoors or outdoors on any surface that is not slippery.

5. **Commands. -**

- a. Most of the techniques described in this manual can be divided into steps or phases. To command execution of a specific technique, all that is required is identification of the technique and intermediate commands to signal execution of each phase or step. For example: The block and reverse punch combination is a five-step technique in practice. To prepare the students, announce:

"FROM FIGHTING STANCE, RIGHT INSIDE LOCK AND REVERSE PUNCH": Students hold natural stance.

"MOVE": Students assume from fighting stance.

"ONE": Students execute right inside block.

"TWO": Students execute left reverse punch.

"THREE": Students resume natural stance.

- b. Until students are completely familiar with the names of movements, it is recommended that an assistant instructor, demonstrate the technique before students execute it.
- c. After the students have learned the technique, this particular movement could be executed in two phases. For example:

"FROM FIGHTING STANCE, EXECUTE RIGHT INSIDE BLOCK AND REVERSE PUNCH": Students hold natural stance. "MOVE": Student step into front forward stance simultaneously executing right inside block, then execute left reverse punch, then resume natural stance.

- d. Similar commands can be used for the other techniques discussed in this manual.

6. **Safety -**

- a. Supervise all training sessions closely.
- b. Do not allow horseplay. Remember, these men are learning to kill.
- c. Do not allow intentional striking of an individual by another. As speed, power and techniques are developed, it won't be long before the student possesses the ability to kill with one or two well placed blows.
- d. During the stages of learning and perfecting techniques, student partners must be made aware of the particular technique to be practiced it is executed.
- e. When practicing counter knife, bayonet, pistol, or rifle techniques, ensure that scabbards are firmly attached and taped on, and that fingers are not placed in trigger guards.
- f. For safety guidelines on CF unarmed combat demonstrations see the respective CFAO and FMCO.

ANNEX B

CALISTHENICS EXERCICES

1. Calisthenics are an essential part of all athletics, and this is especially true for unarmed combat. You must develop mobility, flexibility, and strength to maximize your fighting potential. The better conditioned fighter has the edge.

2. Unarmed combat calisthenics are divided into four (4) parts: Stretching and warm-up exercises, strength building exercises, increasing reaction and speed exercises, and stamina exercises. A suggested daily warm-up routine is as follows:

a. **Stretching -**

- (1) Circle the head - loosen neck muscles.
- (2) Rotate extended arms - loosen shoulder muscles.
- (3) Arm flings - loosen arm and chest muscles.
- (4) Circles from the trunk - loosen stomach and back muscles.
- (5) Toe and floor touch - legs.
- (6) Leg stretches.
- (7) Back stretches with partner.

b. **Strengthening Exercises -**

- (1) Neck exercises - dynamic tentron.
- (2) Arms and fist exercise.
- (3) Stomach - sit-ups and leg raises.
- (4) Legs - squats.
- (5) Ankles and feet - heel raises.

c. **Speed and Stamina Exercises.** These are practiced during class in the form of repetition of basic techniques.